

TMX RR 012 103972 B COVER

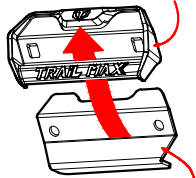

TMX RR 012 103972 B

Bracket
Fitment

59 M6 Plate nut X16

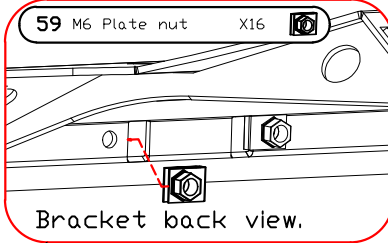

Bracket back view.

PATROL Y61 104092



TMX RR 104066 BRACKET BOLT KIT

Item N°	Part	Description	Qty
24	M8 1,25 Flange nylock nut		8
22	M8 washer		8
89	M8 1,25 x 35 Allen Cap		8
16	M 6 x 20 Allen Bolt		16
59	M6 plate nut		16
68	U Rubber 160mm		8
26	M6 washer		16

- 89 M8 X 35 Allen Cap X 8
- 22 M8 Washer X 8
- 24 M8 Nylock Flange nut X 8

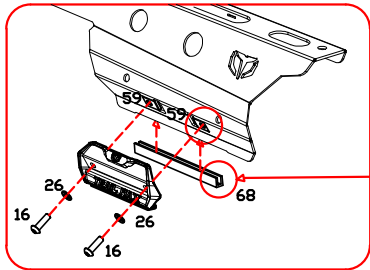
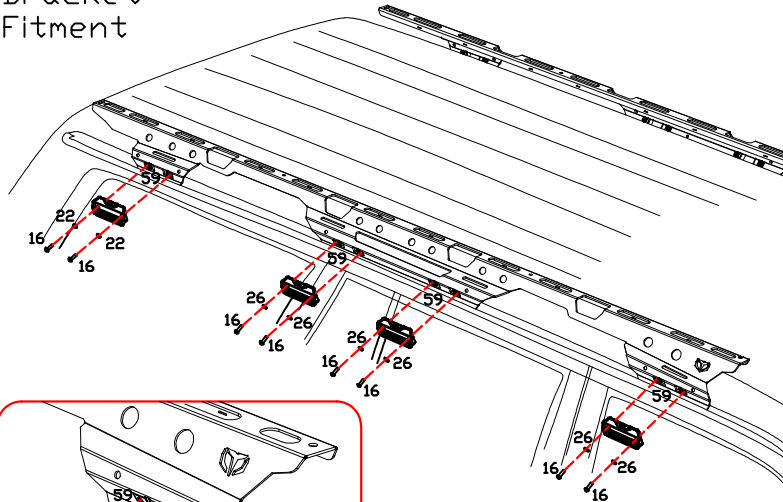

NOTE: Fit U rubber before place bracket on the roof.

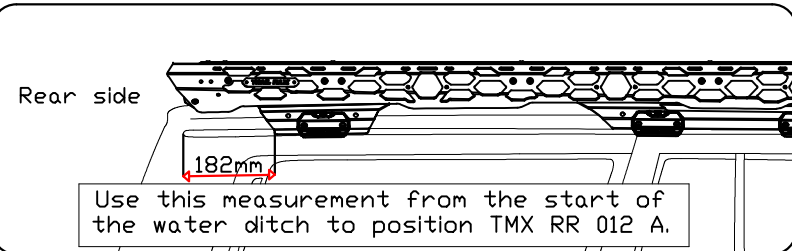
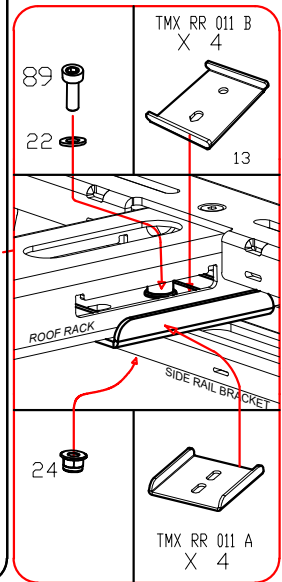
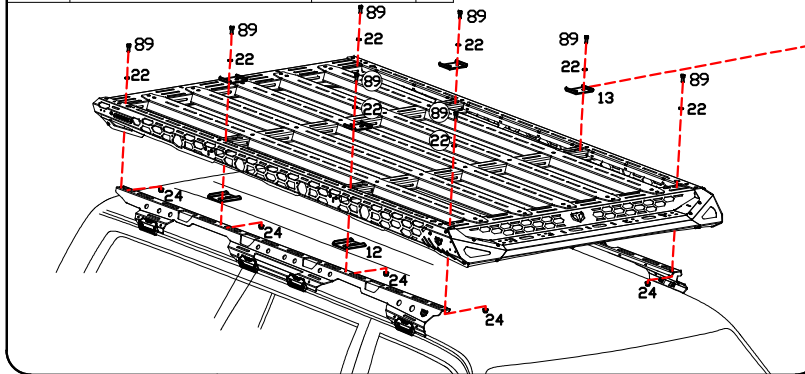

Rear side

182mm

Use this measurement from the start of the water ditch to position TMX RR 012 A.

Tighten all M8 Allen cap bolts and M8 nuts using 6mm Allen key and 13mm Wrench.



DONE!

