

Holden Colorado with original Roof Rails

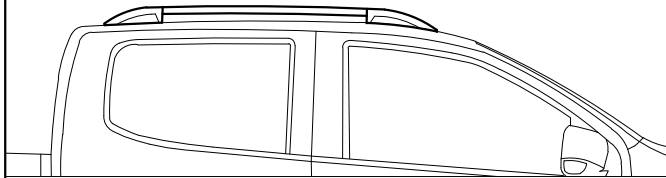

Remove original Roof Rails plastic covers and M8 original bolts

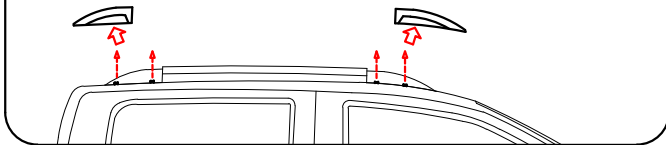

Holden Colorado without original Roof Rails

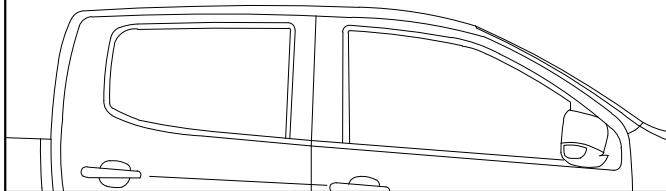

Use these measurements to cut and remove original roof ditch rubber sections.

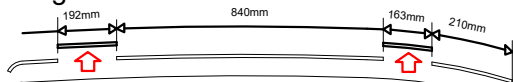

Depending on model, inside of ditch you will find a thread holes under sealant to fit TMX RR 012 103007, if not, use these measurements to drill and fit M8 threaded riv-nut.

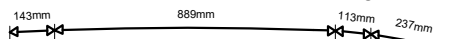

COLORADO D/C 104074

TMX RR 012 104048LH - RH

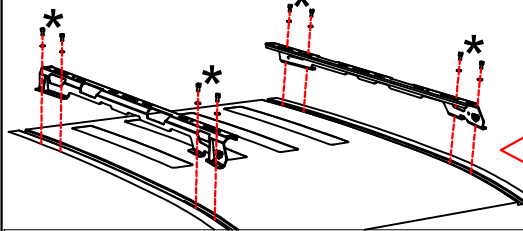

* With Original rails Remove original bolts and use Alen Cap M8 x 16
* Without Original Rails add bolt kit N° 2

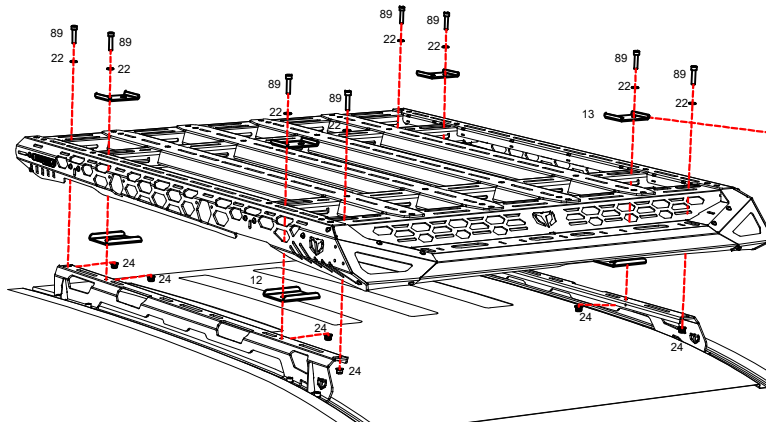

1- Use SEALANT around all roof holes before place brackets to protect and seal.

2- Clean the sealant excess after placement of roof - brackets.

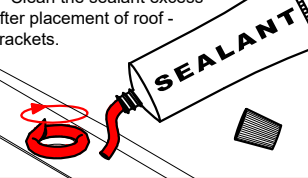

TMX RR 011 B X 4

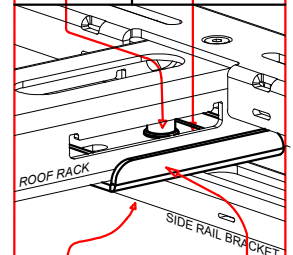
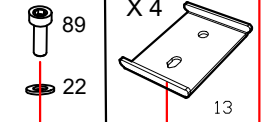

TMX RR 011 A X 4

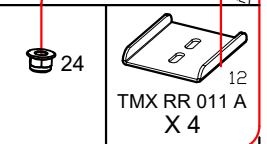

TMX RR 104048 BRACKET BOLT KIT

Item N°	Part	Description	Qty
24	M8 1.25 flange nylock nut		8
89	M8 1,25 x 35 Alen Cap		8
22	M8 washer		16
35	M8 1.25 x 16 Alen Cap		8
Bolt Kit N° 2 to use if does not have threaded holes			
36	M8 Nut Insert 3 - 5.5mm grip		8

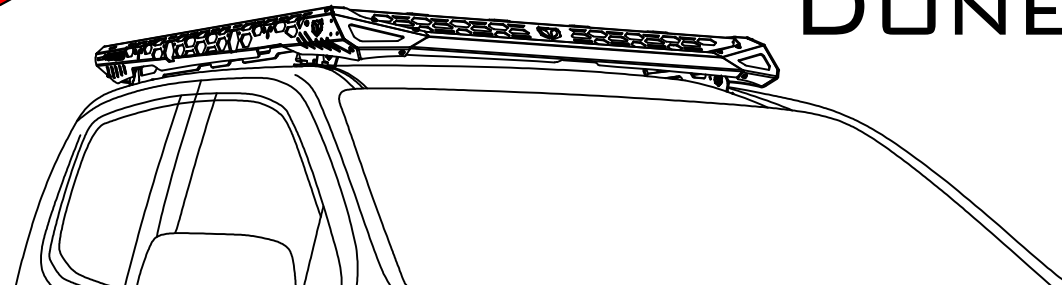

DONE!