



XRS™ **CONNECT**
SMART / ADAPTABLE / RUGGED



XRS-370C Instruction Manual

Compact Hideaway 80 Channel
UHF CB Radio



CONTENTS

INTRODUCTION	1	SCANNING	4	Select a zone	10
Important information concerning UHF CB radio	1	Scan groups.....	4	Edit a zone name.....	10
Emergency channels	1	Programming the scan memories.....	4	Add channels to a new zone.....	11
Telemetry channels	1	Auto skip	5	Edit existing channels in a zone	11
FEATURES	1	Open Scan	5	To select programmable button options..	12
Transmit (TX).....	1	Selecting Open Scan	5	Functions.....	12
Receive (RX)	1	Priority Scan	5	Radio settings	12
Scanning and memory functions	1	Selecting Priority Scan	6	Radio setting options table.....	13
Signal processing	1	Network Scan (Net-Scan).....	6	Scan settings.....	13
Privacy functions.....	1	Enabling Net-Scan.....	6	SelCall.....	13
Physical properties.....	1	Using Net-Scan.....	6	INSTALLATION	14
User controls and interface.....	2	Ending the Scan	6	General	14
XRS CONNECT APP	2	CTCSS AND DCS	6	Installation	14
Pairing	2	Choosing CTCSS or DCS.....	6	Installing the cradle.....	14
GENERAL OPERATION	2	CTCSS tone set compatibility	7	Mounting the cradle.....	14
Front panel.....	2	Busy Lockout.....	7	Fitting the radio	15
Rear panel	2	Monitor function	7	Removing the radio.....	15
Controller microphone.....	2	SELECTIVE CALLING	7	Fitting the controller microphone	15
GENERAL	2	SelCall identification number	7	DC power connection	15
Power	2	SelCall naming	8	Radio remains ON when the ignition switch is OFF	15
Volume	2	The Quiet mode.....	8	Radio turns ON and OFF with the ignition switch.....	15
Selecting channels	2	Sending a SelCall.....	8	High voltage detection.....	15
Squelch.....	2	Receiving a SelCall	8	Antenna connection	15
Adjusting the Squelch level.....	2	Quiet mode.....	8	Noise suppression	16
Signal meter	3	Setting up the Quiet mode.....	8	Wiring.....	16
Brightness	3	Activating the Quiet mode	8	FREQUENCY AND SUBTONE TABLES ...	16
Transmitting.....	3	Receiving signals in the Quiet mode.....	8	CTCSS tone frequencies	16
Time-out timer	3	Scanning in the Quiet mode.....	8	DCS codes.....	17
Busy Lockout.....	3	Group Calling	9	UHF CB operating frequencies	17
Voice scrambler.....	3	Programming and sending Group Calls	9	SPECIFICATIONS	18
Beep tone volume	3	Call acknowledge in Group mode.....	9	Electrical.....	18
Dynamic Volume Control (DVC).....	3	Storing Group Call idents	9	Mechanical specifications and connections.....	18
Selecting the active speaker	3	Receiving Group Calls.....	9	STANDARD COMMUNICATIONS CONTRACT WARRANTY AGAINST DEFECTS	19
Microphone gain	3	MENU OPTIONS	9		
Squelch tail.....	4	Context menu examples	9		
Repeater and duplex mode.....	4	MENU TABLE	10		
Priority channel	4	Receive-only channels (zones)	10		

ACCESSORIES SUPPLIED

- XRS-370C 5 watt UHF CB Radio
- Mounting Cradle (MB009)
- XRS Connect Speaker Microphone (MC664B)
- Microphone Extension Lead (LE040)
- 8 pin to 8 pin Adaptor (AD008)
- Microphone Clip (MB206)
- DC Lead (LE09)
- Screw Pack
- Quick Start Guide

INTRODUCTION

Your GME XRS-370C 80 channel radio is Australian designed and manufactured and is the most advanced UHF Citizen Band radio available. It combines the very latest in electronic hardware with the most up-to-date computer aided design and manufacturing techniques to produce an extremely compact mobile radio with outstanding specifications, features and performance.

The XRS Connect speaker microphone with OLED display and front mounted speaker provides clear sound and total control from the palm of your hand allowing your radio to be mounted almost anywhere in your vehicle.

XRS Connect are the first UHF CB radios with an app to configure and control the radio. Visit gme.net.au/GETXRS for more information.

IMPORTANT INFORMATION CONCERNING UHF CB RADIO

The use of the Citizen Band radio service is licensed in Australia by the Australian Communications and Media Authority (ACMA) Radio communications (Citizens Band Radio Station Class Licence and in New Zealand by the Ministry of Economic Development New Zealand (MED)).

A General User Radio Licence for Citizens Band radio and operation is subject to conditions contained in those licences.

The class licence for users and equipment operating in the CB/PRS 477 MHz band was amended in 2011 to include 80 channels. This radio meets the 80 channel standard.

NOTE: *While operating on the UHF CB band you may still encounter older 40 channel radios on channels 1 to 40, with the possibility of minor interference and varying levels of received volume.*

- If the incoming speech sounds loud and distorted, simply adjust your radio volume for best performance or alternatively, enable the radio's Dynamic Volume Control feature which will automatically compensate for this effect.
- If an older 40 channel radio is transmitting nearby on a channel adjacent it may cause interference to your reception. Simply move up or down a few channels from your currently selected channel.

The above situations are not a fault of the radio but a symptom of operating older 40 channel and newer 80 channel radios within the same band. Any possibility of interference will decrease over time as the population of 40 channel radios ages and decreases.

Further information and updates are available from the ACMA at www.acma.gov.au and the MED, Radio Spectrum Management at: www.rsm.govt.nz

Emergency channels

The ACMA has allocated channels 5/35 for emergency use only. Channel 5 is the primary Simplex Emergency Channel.

Where a Channel 5 repeater is available, you should select Duplex on CH 5.

NOTE: *Channel 35 is the input channel for the Channel 5 repeater therefore Channel 35 should also not be used for anything other than emergency transmissions.*

Telemetry channels

ACMA regulations have allocated channels 22 and 23 for telemetry only applications and have prohibited the transmission of speech on these channels. Consequently your radio has a transmit inhibit applied to channels 22 and 23.

In the event additional telemetry/telecommand channels are approved by the ACMA, these channels shall be added to those currently listed where voice transmission is inhibited.

Currently transmissions on channels 61, 62 and 63 are also inhibited and these channels are reserved for future use.

FEATURES

Transmit (TX)

Individually Programmable DUPLEX Function: User selectable for only those individual channels in your area that have repeaters, leaving the others free for use as extra simplex channels.

Receive (RX)

Squelch Tail: Can be switched off to eliminate the audible noise burst normally heard when the Squelch closes.

User Programmable Receive Channels: 8 zones of 50 channels per zone for a total of 400 additional receive-only channels.

Digital Signal-Strength Meter: Provides a numeric signal strength indication in numbers from 0 to 9+.

Scanning and memory functions

Microprocessor Controlled Frequency Synthesiser: Allows user programmable control of scanning, channel memories and selected feature options.

Programmable Scan Function: Scans the selected UHF CB channels with Open, Priority and Network scan functions available.

Priority Channel: A user programmable Priority channel for instant recall at the press of a key.

Signal processing

Digital Signal Processing (DSP): Measures, filters and compresses standard analogue audio signals and converts them into digital format. Allows advanced RF and audio processing techniques to be applied to maximise the radio's performance.

Advanced Signal Management (ASM): Identifies interference caused by strong local signals on adjacent channels and prevents these from opening your Squelch. ASM also minimises distortion on reception by fine tuning the receiver frequency to match that of the incoming signal.

Dynamic Volume Control (DVC): Automatically compensates for variations in received audio level to provide a constant audio output level to the speaker.

Privacy functions

Voice Inversion Scrambler: When activated, scrambles your voice so that communications are only intelligible to others using the same scrambler technology.

Inbuilt CTCSS and DCS: User selectable Continuous Tone Coded Squelch System and Digital Coded Squelch system provides silent operation on individual channels.

In-Built SelCall with Quiet Mode: Provides selective calling of individuals or groups with fully user-adjustable 5-tone transmitted SelCall Ident. Also allows alphanumeric naming of up to 20 Idents for easier caller identification.

Physical properties

Over Voltage Protection: Special over voltage detection circuitry protects the radio and warns of excessive voltage conditions on the display.

Rugged Construction: With die-cast chassis.

User controls and interface

Full Function Controller Microphone: Includes front mounted speaker to channel clear audio towards the user.

OLED Display: Bright, high contrast, dot matrix OLED display is readable under all lighting conditions.



A more detailed description of these key functions is included right.

XRS CONNECT APP

The **GME XRS Connect** app is the easy way to customise, update and maintain your XRS Connect radio. To download the free XRS Connect app for iOS or Android go to the App Store or Google Play and search for '**XRS Connect**'. Register the XRS Connect app and receive an additional one year warranty – available for a limited time.

XRS Connect are the first UHF CB radios with an app to configure and control the radio. Visit gme.net.au/GETXRS for more information.

Pairing

To pair your Smart Device with your XRS Connect radio, open the XRS Connect app, go to the 'My Radio' tab and select 'Connections'. Locate your radio in the list and select 'Pair'. Next, press 'Connect' next to your radio in the list, and your app will return to the 'My Radio' screen and the  icon on your radio should change to  to show that the **Bluetooth** wireless technology enabled pairing is successful.

Once connected, select the 'Read from Radio' button to read your radio's settings into the app. After you have configured your preferences in the app, select 'Write to Radio' to update your radio with your new settings.

NOTE: The Bluetooth wireless technology enabled connection between your smart device and your XRS Connect radio must be made through the XRS Connect app. You will not be able to pair your smart device to your XRS Connect radio using the normal Bluetooth wireless technology enabled settings option on your smart device.

The XRS Connect app is compatible with iOS 9.0 and above and Android 5.0 and above. A full list of compatible devices and application software is available at gme.net.au/GETXRS

GENERAL OPERATION

Front panel



Rear panel

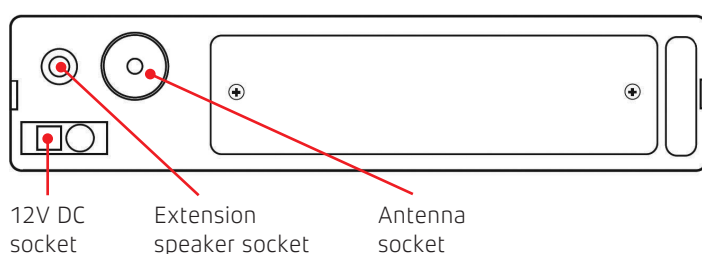

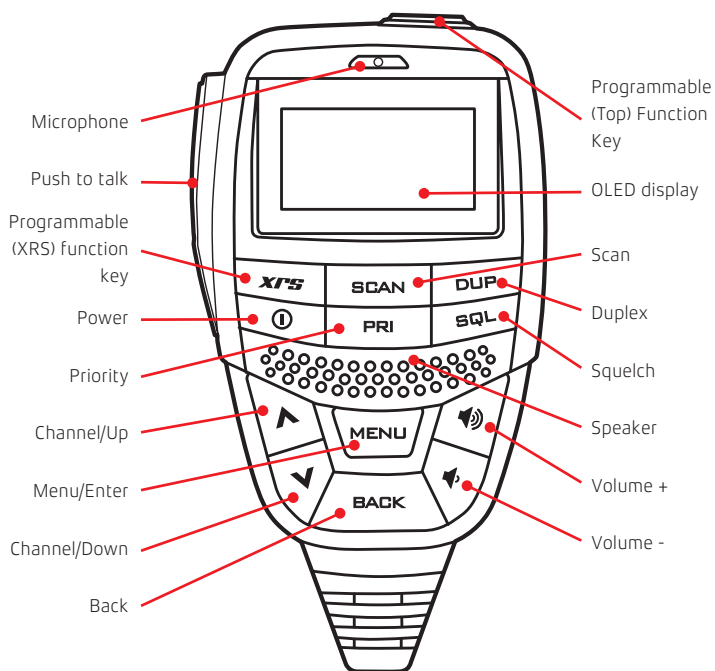

Controller microphone







GENERAL

Power

Press and hold the  key to turn the radio on. Press and hold the  key to turn the radio off.

Volume

Press the  or  keys to adjust the volume. Press  to increase the volume or  to decrease the volume. The volume level is displayed on the OLED Display in values from 01 (min) to 31 (max).

If no sound is heard, briefly press the **SQL** key to temporarily un-mute the radio then adjust the volume while listening to the background noise. When finished, briefly press the **SQL** key again to re-mute the radio.

NOTE: At the minimum volume setting there is still sufficient volume to be heard in a quiet cabin environment.

Selecting channels

To select a channel, press the  or  key. Press  to select a higher channel or  to select a lower channel. The selected channel is displayed on the OLED Display.

Press and hold either key to advance quickly through the channels.

Squelch

The Squelch is used to eliminate any annoying background noise when there are no signals present. The Squelch can be opened or closed using the **SQL** key. When the Squelch is open the receiver's background noise can be heard and the  icon is displayed. When the Squelch is closed the receiver remains quiet while there are no signals present but any incoming signals will override the Squelch and be heard in the speaker.

Adjusting the Squelch level

The Squelch sensitivity level has been factory set to provide optimum performance under most operating conditions. If required, the sensitivity level can be adjusted to suit changing conditions.

To adjust the Squelch sensitivity, refer to the **MENU / RADIO SETTINGS** options. The default squelch sensitivity level is 3.

Signal meter

The signal meter indicates the relative strength of the incoming signal in numerical format. Signal strengths are displayed on the right of the Channel Display in values from 0 to 9. Signals above strength 9 are displayed as 9+.

Brightness



The OLED display and keys are backlit for easier viewing under a wide range of lighting conditions. The backlight remains on whenever the radio is switched on. The brightness level can be smoothly adjusted in steps from 0 to 10. To adjust the brightness level, refer to the **MENU / RADIO SETTINGS** options.

A Dim function can also be assigned to the programmable **XRS** key to quickly switch the brightness level to minimum for low light viewing. This saves having to manually readjust the brightness level when moving into low light environments.

To assign the Dim function to a key, refer to the **MENU / PROG BUTTONS** options.

Transmitting

Prior to transmitting, always check the channel is clear. This can be done by listening to the channel or by visually checking that the  icon is not visible or the signal meter is not indicating a signal.

To transmit, press the **PTT** on the microphone. The  icon will appear. Hold the microphone about 3-5 cm from your face and speak at a normal voice level. The microphone is quite sensitive so it is not necessary to raise your voice or shout. Release the **PTT** when you have finished talking, the  icon will disappear.



IMPORTANT: Always listen to ensure the channel is free before transmitting.

Time-out timer

The radio has a built-in time-out timer that automatically limits transmissions to a maximum of 3 minutes of continuous operation. This feature is required by the ACMA to prevent accidental blocking of the frequency should your **PTT** become jammed or be otherwise pressed accidentally.

When the time-out timer activates, the radio will give a low tone for a few seconds and the transmitter will be temporarily disabled. Release the **PTT** to restore normal operation.

Busy Lockout

When enabled, the **Busy Lockout** function detects when someone is transmitting on the channel and prevents your radio from transmitting over them. If you press the **PTT** when the channel is busy the radio will emit a warning beep and the  icon won't be displayed. If this happens, look for the  icon on the display as an indicator that the channel is already in use. If the channel is busy, simply wait until the channel is clear and press the **PTT** again.

When **Busy Lockout** is disabled, you should check that the channel is clear before pressing the **PTT** to avoid transmitting over others who may be already transmitting on the channel.

To enable or disable **Busy Lockout**, refer to the **MENU / RADIO SETTINGS** options.

Voice scrambler

Your radio incorporates a simple voice scrambler using band inversion. The scrambler is compatible with the majority of scramblers used by other manufacturers, allowing you to enjoy

scrambled communications with owners of non-GME radios. Once the scrambler has been activated your transmission and reception will only be intelligible to others using the same scrambler technology.

To enable or disable the voice scrambler, refer to the **MENU / RADIO SETTINGS** options.

NOTE: To avoid interference with other services or users, the scrambler cannot be enabled on channels 5, 11, 22, 23, 31-38, 61, 62, 63, 71-78 or on any channel that has been set to Duplex mode (1-8)

Beep tone volume

The Beep tone provides audible feedback whenever the keys are pressed. The Beep tone volume can be adjusted in values from 0 – 10. To switch the beep off, select 0.

To adjust the volume of the Beep tone, refer to the **MENU / RADIO SETTINGS** options.

Dynamic Volume Control (DVC)

The modulation level of signals heard on the UHF CB band has always varied considerably resulting in noticeable differences in received audio volume between stations.

Generally, users have compensated for this by adjusting the Volume control for each incoming signal.

With the introduction of 80 channel narrowband transmissions that use lower levels of modulation, the differences in received audio volume is likely to increase further.

Your XRS-370C radio is able to automatically compensate for these variations by utilising a Dynamic Volume Control. When activated through the menu, this feature automatically compensates for variations in received audio level resulting in a constant audio output level to the speaker.

To activate the Dynamic Volume Control, refer to the **MENU / RADIO SETTINGS** options.

Selecting the active speaker

The XRS-370C has two speakers - one mounted inside the radio and the other mounted inside the microphone.

By default, sound is reproduced by both speakers; however if you prefer, one of these speakers can be switched off, leaving either the radio's internal speaker or the microphone's speaker to reproduce sound.

To select which speakers are turned on, refer to the **MENU / RADIO SETTINGS** options.

Microphone gain

The microphone gain controls the sensitivity of the microphone to your voice input level. If you are quietly spoken or are operating in a quiet environment you can increase the microphone gain to make your voice sound clearer. If your voice is quite loud or you are working in a noisy environment and wish to minimise the amount of background noise that is picked up, you should reduce the microphone gain.

To adjust the microphone gain, refer to the **MENU / RADIO SETTINGS** options.

NOTE: The Microphone Gain provides a 'fine' adjustment to the microphone sensitivity. A wider adjustment range is available through the XRS Connect App.

Squelch tail

The Squelch Tail is the short burst of noise that is heard in the speaker at the end of a transmission just before the Squelch closes. To some it is a reassuring confirmation that it is their turn to transmit but in some applications it may be an annoyance especially when listening through an earpiece or headphones.

The Squelch Tail can be turned off, reducing it to a faint click as the Squelch closes.

To enable or disable the Squelch Tail, refer to the **MENU / RADIO SETTINGS** options.

Repeater and duplex mode

Duplex operation allows the radio to transmit on a different frequency to that which it receives. This allows operation through repeater stations.

A repeater station consists of a linked transmitter/receiver combination installed in a prominent location. The repeater is designed to receive signals on a designated channel and retransmit them on another channel. Repeaters are usually mounted on hills or tall buildings. The increase elevation greatly improves both the receiving and transmitting range of the repeater allowing it to receive and retransmit signals to radios that would otherwise be out of range of each other.

Normally, UHF CB radios transmit and receive on the same frequency - known as Simplex operation. However, to communicate through repeaters, your radio must be able to transmit and receive on different channels - otherwise known as Duplex operation. Your radio is fitted with a Duplex key to allow you to operate through repeaters.

The Duplex function can only be selected on channels 1 - 8 and 41 - 48 as these are the channels that have been allocated for repeater use. When Duplex is selected, your radio receives on the selected channel (e.g. CH 1) but transmits 30 channels higher (CH 31). The repeater hears your signal on CH 31 and retransmits it on CH 1 for others to hear.

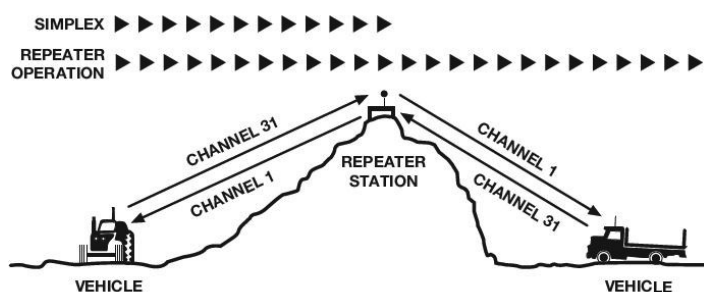



Your XRS-370C radio allows you to enable or disable Duplex mode on individual repeater channels. In this way any repeater channels that are not being used with repeaters in your area can be used in Simplex mode for normal direct radio-to-radio communications.

To enable Duplex on a repeater channel

- 1 Select the required repeater channel (1 - 8, 41 - 48).
- 2 Briefly press the **DUP** key. The  icon will appear on the display accompanied by a high beep.

To remove Duplex from a repeater channel

- 1 Select the required repeater channel (1 - 8, 41 - 48). If duplex is currently selected, the  icon will be displayed.
- 2 Briefly press the **DUP** key. The  icon will disappear from the display accompanied by a low beep.

IMPORTANT: Channels 1 - 8, 31 - 38, 41 - 48 and 71 - 78 should
[BACK TO CONTENTS](#)

only be used in Simplex mode if there are no repeaters in or near your location that operate on the selected channel. In particular, avoid operating in Simplex mode on any of the repeater input channels 31 - 38 and 71 - 78 unless you are absolutely sure that there are no repeaters in range using that channel. Inadvertently transmitting on an active repeater input frequency in simplex mode could cause interference to other users on that repeater who might not be audible to your radio.

Priority channel

The Priority channel feature allows you to instantly recall any one of the 80 CB channels in your radio. This feature can be used to provide instant access to your working channel or your local repeater channel at the press of key. It is also used in conjunction with the Priority Scan mode.

To store a Priority channel

- 1 Select the required channel.
- 2 Press and hold the **PRI** key. The channel number will flash for a few seconds then a high beep will be heard as the channel is stored. The 'PRI' icon will now be visible whenever that channel is selected.

NOTE: The Priority channel can also be set through the Menu.

To recall a Priority channel

- 1 Briefly press the **PRI** key. The radio will immediately switch to the Priority channel and 'PRI' will be displayed.

NOTE: If the radio was scanning when the Priority channel was recalled, the scan will be cancelled.

SCANNING

Your radio incorporates a scan function allowing selected groups of channels to be scanned for signals. Channels can be scanned at a rate of 50 channels per second.

When a signal is found, scanning will pause to allow the signal to be heard then resume scanning when the channel is clear again.

Scan groups

Your radio supports three Scan Groups - Open Scan, Priority Scan and Network Scan.

Open Scan lets you sequentially scan from 2 to 80 user-selectable CB channels.

Priority Scan lets you constantly monitor your priority channel while scanning a group of user-selectable CB channels.



Network Scan allows a group of radio users to maintain communications even when the band is congested by monitoring a small group of user selectable channels. If the operating channel becomes busy with users from outside your group, Net-Scan will automatically select a new free channel from the scan group and transparently switch all users in your group to the new channel.





To select Open Scan, Priority Scan or Network Scan, refer to the **MENU / SCAN SETTINGS** options.

Programming the scan memories

Each Scan Group has its own separate channel memory allowing you complete freedom to program your choice of channels into each group.

To add or remove channels from the selected Scan memory:

- 1 Select the required channel using the  or  key.
- 2 Check to see if the  icon is displayed on that channel.

- If  is displayed, the selected channel is already in the scan memory. To remove it, press and hold **SCAN**. A low beep will be heard and  will disappear.
- If  is not displayed, the selected channel is not in the scan memory. To add it, press and hold **SCAN**. A high beep will be heard and  will appear on that channel.

Repeat to add or remove other channels in the scan memory.

IMPORTANT: When adding channels to Net-Scan, please consider the following:

- The transmitter on your radio is inhibited on channels 22, 23 and channels 61, 62, 63 as required by the ACMA. This makes these channels unsuitable for use as Net-Scan channels.
- You should not include any repeater channel unless you have confirmed that the channel is not allocated to repeaters in your area. Using an active repeater channel in Net-Scan may result in interference to repeater users on that channel.

Auto skip

While scanning, if an active channel in your Scan Group becomes a nuisance by constantly interrupting the scan, briefly press **▲** or **▼** while the radio is paused on that channel. The busy channel will be temporarily removed from the Scan Group to allow time for the channel to become clear again and scanning will continue from the next channel in the sequence. After 30 seconds the skipped channel will be reinstated in the scan sequence.

If the unwanted active channel continues to interrupt the scan even after the 30 second skip period has elapsed, hold **SCAN** while the radio is paused on that channel. The 'nuisance' channel will be completely removed from the Scan Group for the duration of that scan session. To restore the channel, simply stop and restart the scan session using the **SCAN** key (or switch the radio Off then On again).

NOTES:

- 1 You can skip as many busy channels from the Scan Group as you wish, however if you attempt to skip the last remaining channel, all the previously skipped channels will be restored to the Scan Group.
- 2 The length of the skip period can be adjusted through the **XRS Connect App**.

Open Scan

Open Scan allows a group of channels to be scanned in an ascending sequence. If a signal is found, the scan will pause on that channel. During this time you can press the **PTT** on the microphone and talk on the channel. Once the channel has been clear for 5 seconds the scan will resume.



Example: Scanning Channels 1 - 8 in open scan

Selecting Open Scan

To select Open Scan, refer to the **MENU / SCAN SETTINGS** options.

Default working channel in Open Scan mode

In the Open Scan mode, your default working channel is the channel your radio switches to when you press the **PTT** while scanning. To set your working channel simply select the required

channel before you press **SCAN**. e.g. to make channel 24 your working channel, simply select channel 24 before pressing **SCAN**.

To begin scanning

Briefly press **SCAN**. A high beep will be heard, '**SCANNING**' will be displayed and the  icon will animate. During this time the scan mode and the number of channels being scanned will be displayed along with the selected Zone.

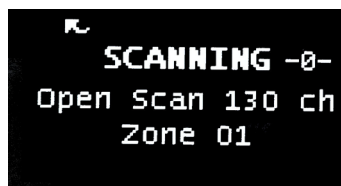

NOTE: If there are less than 2 channels programmed into the scan memory when you press **SCAN**, a low beep will be heard and the command will be ignored.

Operating in the Open Scan mode

If a busy channel is found, scanning will pause to allow the signal to be heard and will remain there for as long as the channel remains busy. Once the channel has been clear for 5 seconds, scanning will resume automatically.

If you don't wish to listen to a busy channel, briefly press **▲** or **▼** while the radio is paused on that channel. The busy channel will be temporarily removed from the Scan Group to allow time for the channel to become clear again and scanning will continue. The skipped channel will be reinstated in the scan sequence after 30 seconds (see Auto Skip).

If you press the **PTT** while the radio is scanning, the scan will pause and the radio will transmit on the working channel.

After the channel has remained clear for 5 seconds scanning will resume.

If your radio pauses on a busy channel and you wish to talk on that channel, wait for a break in the conversation then press the **PTT**. If the busy channel was not your working channel, it now becomes your working channel, replacing your previous working channel. Once your communication has finished and the channel has been clear for 5 seconds, scanning will resume.

If you need to use your Priority channel at any time, briefly press **PRI**. The scan will be cancelled and the radio will jump straight to the Priority channel.

Priority Scan

Priority Scan allows you to scan a number of channels for activity while also monitoring your Priority channel. The receiver will scan the other channels ONLY WHILE THERE ARE NO SIGNALS ON THE PRIORITY CHANNEL. If a signal appears on the Priority channel it will override any signals being received on any of the other channels. In addition, if you press the **PTT** at any time, the radio will transmit on the Priority channel.



Example: Scanning channels 1 - 8 with priority channel 20 in Priority Scan

NOTE: By default the priority channel will be scanned after every 5th scan channel. This timing can be adjusted using the **XRS Connect App**.

Selecting Priority Scan

To select Priority Scan, refer to the **MENU / SCAN SETTINGS** options.

To begin scanning

Briefly press **SCAN**. A high beep will be heard, 'SCANNING' will be displayed and the  icon will animate. During this time the scan mode and the number of channels being scanned will be displayed along with the selected Zone.

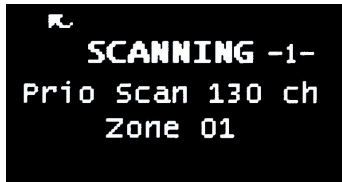

- If a signal appears on the Priority channel - at any time - the radio will switch directly to the Priority channel and will stay there for as long as the channel remains busy. During this time you can transmit and receive on the Priority channel.

Once the Priority channel has been clear for 5 seconds the radio will resume scanning the other channels.

- If a signal appears on any other channel, scanning will pause on that channel and will remain there while the channel is busy - as long as there are no signals on the Priority channel.

During this time, the receiver will continue to check the Priority channel every 2 seconds resulting in a series of small breaks in the reception. Once the signal has gone and there has been no activity for 5 seconds, the radio will resume scanning.

- If the radio is paused on a busy channel and you want to remain there, briefly press **SCAN**. The radio will exit scan and remain on the busy channel. At this point you will no longer be monitoring the Priority channel.

To resume the Priority Scan press **SCAN** again.

- If you don't wish to listen to a busy channel, briefly press the **▲** or **▼** key while the radio is paused on that channel. The busy channel will be temporarily removed from the Scan Group to allow time for the channel to become clear again and scanning will continue. The skipped channel will be automatically reinstated in the scan sequence after 30 seconds (see 'Auto skip').
- To transmit on the Priority channel at any time, simply press the **PTT**. The radio will switch straight to the Priority channel.

When you have finished your conversation and there has been no further activity for 5 seconds, the radio will resume scanning the other channels.

To jump straight to the Priority channel at any time, briefly press the **PRI** key. The scan will be cancelled.

Network Scan (Net-Scan)

Net-Scan allows a group of radio users to maintain communications even when the band is congested.

To achieve this, all members of the Net-Scan group must share a common CTCSS/DCS code and a common set of scan channels.

Once activated, Net-Scan's intelligent scanning software keeps track of clear channels within your Scan Group. When any member of the group first transmits, their radio automatically selects a clear channel to transmit on. Other radios scanning in the same Net-Scan group will detect the common CTCSS/DCS code and lock onto that channel allowing all members of the group to join the conversation.

If a signal from outside your Net-Scan group transmits on the selected channel without using your chosen CTCSS/DCS code, the group will automatically switch to a new clear channel at the next transmission. In this way the group can continue to communicate with minimal interference to or from other users.

Enabling Net-Scan

To select Network Scan and a suitable CTCSS/DCS code, refer to the **MENU / SCAN SETTINGS** options.

Using Net-Scan

With Net-Scan mode enabled, briefly press **SCAN**. A high beep will be heard, 'SCANNING' will be displayed and the  icon will animate. During this time the scan mode and the number of channels being scanned will be displayed along with the selected Zone.

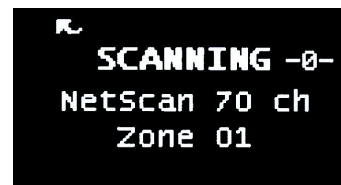

When a member of the group initiates a transmission their radio will automatically select a clear Net-Scan channel to transmit on.

Other radios scanning in the same Net-Scan group will locate the transmission by identifying the groups CTCSS/DCS code, pause on that channel and open their Squelch, allowing the transmission to be heard across the entire group. When the transmission ends, all radios in the group will immediately resume scanning.

If a member of the group responds to the initial transmission, they will automatically re-use the same channel as long as the channel remains free of other signals. This allows the radios in the group to respond more quickly to further transmissions from others in the group.

If at any time a signal from outside your Net-Scan group transmits on the selected channel without using your chosen CTCSS/DCS code, the channel will be discarded and a new clear channel will be selected at the next transmission. The other radios in the group will then relocate to the new channel allowing the conversation to continue seamlessly without any input from the user.

Ending the Scan

To stop scanning, briefly press **SCAN**. A low beep will be heard and the  icon will stop animating. As long as the radio was not on a busy channel, it will return to the last channel you selected, otherwise it will stay on the busy channel.

CTCSS AND DCS

The standard Squelch system operates solely on signal strength which means that it will open to any signal that is strong enough. If the selected channel is busy with other stations the Squelch will be opening constantly making it difficult to determine which calls are meant for you.

CTCSS (Continuous Tone Coded Squelch System) and DCS (Digital Coded Squelch) are similar Squelch quieting systems that provide selective audio muting using sub-audible signalling. When CTCSS or DCS is enabled, only signals with a matching sub-tone will be heard in the speaker. This effectively creates a channel that is silent to all traffic except those you wish to hear.

Choosing CTCSS or DCS

The CTCSS system uses 1 of 50 low frequency tones to open and close the Squelch on the radio. The DCS system is similar

to CTCSS but uses 1 of 104 digital codes to control the Squelch. There is no difference in performance or function between CTCSS or DCS so choosing which system to use will largely depend on the other radios you talk with. If others already use CTCSS or DCS, you should select the system that matches theirs. If the users you talk to don't currently use CTCSS or DCS then you can make your own choice. Both types are included in the radio to maintain compatibility with other radio systems.

CTCSS tone set compatibility

The GME CTCSS tone set comprises 50 tones made up of the standard CCIR-38 Tone Set plus an additional 12 tones added to the end. If communicating with other brands of radios that only use the CCIR-38 tone set, please select from one of the first 38 tones to ensure compatibility with these radios.

If communicating with other GME radios, you may choose from any of the 50 tones. However, to ensure compatibility, please refer to the tone set table listed in each radio's Instruction manual because the tones used in older GME models may be listed in a different order to those in your radio.

To select a CTCSS or DCS code, refer to the **MENU / RADIO SETTINGS** options.

Enabling CTCSS/DCS on a channel (Silent mode)

Enabling CTCSS/DCS on a channel will prevent the Squelch from opening on that channel unless the incoming signal matches your selected CTCSS/DCS tone. Other users on the same channel who are not using your CTCSS/DCS tone will still be received by your radio (the  icon will still appear on the display) but they will not be heard in the speaker.

Only when someone transmits on the channel using your CTCSS/DCS tone will the Squelch open to allow the signal to be heard. Channels where CTCSS/DCS have been enabled are said to be in 'Silent mode'.

NOTE: *Silent mode can be enabled on any channel except emergency channels 5 and 35.*

To enable Silent mode on a channel

- 1 Press **MENU** and select 'FUNCTIONS'.
- 2 Select 'TOGGLE SILENT' then press **MENU** to select 'ON'
- 3 An **S** icon (CTCSS) or **S**  icon (DCS) will be displayed at the top of the display to indicate Silent mode is now enabled on that channel.

NOTE: *You cannot enable Silent mode unless a CTCSS or DCS tone has been selected in the 'RADIO SETTINGS' menu. If CTCSS/DCS has been set to OFF, Silent mode is inhibited.*



To disable Silent mode on a channel

- 1 Press **MENU** and select 'FUNCTIONS'.
- 2 Select 'TOGGLE SILENT' then press **MENU** to select 'OFF'
- 3 The **S** icon (CTCSS) or **S**  icon (DCS) will be disappear from the display to confirm Silent mode is now disabled on that channel.

IMPORTANT: *When Silent mode is enabled on a channel you should always check the icon for signs of traffic on the channel before transmitting to ensure you do not accidentally transmit over the top of another user. Alternatively, you can enable Busy Lockout in the menu which will automatically prevent your radio from transmitting if the channel is already in use.*

Busy Lockout

When using Silent mode with CTCSS/DCS, your radio's receiver remains quiet to all signals outside your CTCSS/DCS group. As a result, if you do not notice when others are transmitting on your channel you could accidentally transmit over the top of them.



The Busy Lockout function detects when others outside your CTCSS/DCS group are transmitting on the channel and prevents your radio from transmitting over them. If you press the **PTT** when the channel is busy the radio will emit a warning beep and the  icon won't be displayed. If this happens, look for the  icon on the display as an indicator that the channel is in use. If the channel is busy, simply wait until the channel is clear and press the **PTT** again.

To enable or disable Busy Lockout, refer to the **MENU / RADIO SETTINGS** options.

NOTE: *A 'Busy Lockout Override with CTCSS Match' option is available through the XRS Connect App. When this option is enabled, Busy Lockout will not prevent you from transmitting over the top of another signal where their CTCSS/DCS code matches yours (i.e. The signal is from a member of your group)*

Monitor function

When the current channel is in Silent mode, you may see the  icon appear but hear no sound in the speaker. This indicates that your radio is receiving a signal that does not match your CTCSS/DCS tone.

Press the  key to briefly monitor signals on the channel. The Silent mode will be temporarily disabled while the  key is pressed allowing you to hear signals on the channel. When you release the  key, Silent mode is restored and the radio becomes quiet again.

NOTE: *You will only have a brief moment to monitor the channel for signals because holding the  key for more than a few seconds will switch the radio off.*

SELECTIVE CALLING

Your radio has a Selective Calling system known as SelCall that operates like a telephone. Your radio is pre-programmed with its own unique SelCall Identification number. If this number is called by another radio, your radio will beep to alert you. If you do not want to hear any other activity while waiting on a channel, you can select the QUIET mode. Your radio will then remain quiet to all incoming signals until your SelCall number is called.

You can store up to 20 of your most frequently called SelCall numbers in memory and each number can be labelled for easy identification.

SelCall identification number

Your radio is factory programmed with its own unique SelCall Identification Number. This number identifies your radio from others in your area. Your radio's own SelCall Ident will be displayed for a few seconds to the lower-left of the display when you first turn the radio on. You will need to make your Ident known to anyone who may need to call you using SelCall.

NOTE: *Although your radio is factory-programmed with a unique SelCall Ident, you can change your Ident to another number if required, using the **MENU / SelCall** option.*

SelCall naming

When storing SelCall numbers, you can add names to each one to make it easier to identify whose number you are recalling. In addition, if an incoming SelCall matches one of your stored numbers, the name will be displayed to identify the caller.

The Quiet mode

Your radio can be set to monitor signals on a busy channel but remain Quiet unless it receives its own SelCall Ident.

In this way, you won't be disturbed unless someone calls you. When your SelCall Ident is received, the Quiet mode is deactivated and an alarm sounds to alert you to the call. You can then converse normally on the channel.

NOTE: The QUIET mode overrides the normal Squelch system to ensure that the radio remains quiet even when the channel is busy. When QUIET is set, you may see the  icon appear on the display indicating the channel is being used. However, unless someone transmits your SelCall Ident, nothing will be heard in the speaker.

You can activate the QUIET mode on individual channels (i.e. Some channels can be set to remain Quiet while others can remain open to all incoming signals) by storing those channels into a Quiet Memory.

Sending a SelCall

To send, program or change a SelCall number, refer to the **MENU / SelCall** options.

Receiving a SelCall

When your radio receives its own SelCall number, the  icon will appear along with the callers SelCall number and name and the radio will sound an alarm to alert you to the call. During this time the alarm will beep urgently and the Quiet mode (if enabled) will open to allow incoming calls to be heard. After 30 seconds, if the call is not answered, the alarm will slow and the Quiet mode will be reactivated. The alarm will then continue to beep slowly until you cancel it.

To cancel the Alarm but leave the incoming SelCall Ident on the display:

- Briefly press the **TOP** key on the top of the microphone. The alarm will stop but the caller's name and SelCall number will remain on the display and the channel will remain open to any incoming signals. This feature is useful if you are currently busy but intend to call the person back later.

To cancel the Alarm and talk on the channel:

- Press the **PTT** and talk in the usual way. The alarm will be cancelled, the display will return to normal and the channel will be open for normal communication.

To clear the alarm completely

- Briefly press **BACK**. The alarm will be cancelled and the display will return to the normal screen.

Quiet mode

The Quiet mode mutes the receiver to prevent incoming signals from being heard in the speaker until your SelCall Ident is received. In this way you can monitor a busy channel for personal calls without being disturbed by unwanted signals. If your SelCall number is received, the Quiet mode is cancelled and all incoming signals are heard in the speaker.

Setting up the Quiet mode

To setup the Quiet mode you must first store the individual channels that you want to stay quiet into the Quiet memory. When the required channels are stored, simply activate the Quiet mode and all stored channels will remain quiet to all incoming signals unless your SelCall Ident is received.

Channels not stored in the Quiet memory will remain open to all signals and will operate normally.

To store individual channels into Quiet memory

- 1 Select the required channel.
- 2 Press **MENU** and select 'FUNCTIONS'.
- 3 Select 'TOGGLE Q MEM' and press **MENU** to select 'ON' or 'OFF'.

When Quiet memory is switched 'ON' on the selected channel, 'Q' will appear at the top of the display indicating the selected channel is now stored in the Quiet memory.

When Quiet memory is switched OFF on the selected channel, 'Q' will disappear from the display indicating the channel is no longer stored in the Quiet memory.

Activating the Quiet mode

- 1 Select a channel that has been stored in the Quiet memory. 'Q' will be displayed.

NOTE: You cannot activate the Quiet mode unless you have selected a stored channel.

- 2 Press **MENU** and select 'FUNCTIONS'.
- 3 Select 'TOGGLE QMode' and press **MENU** to select 'ON' or 'OFF'.

When Quiet mode is switched ON,  will appear at the top of the display indicating that Quiet operation is enabled. Now, all channels stored in the Quiet memory will be operating in the Quiet mode.

When Quiet mode is switched OFF,  will disappear from the display indicating that Quiet operation is disabled. Now, all channels stored in the Quiet memory will be open for signals.

Receiving signals in the Quiet mode

- If a normal signal is received on a Quiet channel, the channel will appear busy (the  icon will be visible) but no sound will be heard from the speaker.
- If a normal signal is received on an Open channel (one that is not in the Quiet memory) the signal will be heard in the usual way.
- If your SelCall Ident is received on any channel - Open or QUIET - the Quiet mode will be cancelled and the alarm will beep to alert you to the call. In addition, the caller's name and number will be displayed. All channels will now be open for normal transmission and reception.

Scanning in the Quiet mode

The radio will allow you to scan while the QUIET mode is active. Using this feature you can monitor a group of Quiet channels or a combination of Quiet and Open channels.

TIP: To ensure reliable SelCall detection when scanning in the Quiet mode, it is recommended that you restrict the number of channels in the Scan Group.

Group Calling

The SelCall system includes a Group Call function that allows you to call up to 1000 radios simultaneously. This can be useful in an emergency situation where you may need to transmit a message to a large number of radios in your group.

By default, your radio is factory-set to allow up to 10 radios to be called at once. If your application requires more, your dealer can re-program this option to allow 100 or even 1000 radios to be called. The following description assumes the default Group Call setting of 10 radios.

The Group Call function works by allowing you to enter a special 'group code' into the last digit of the SelCall number you are sending. The 'group code' appears as an 'A' (All) when displayed in the radio. When this 'group code' is received, it substitutes for all other numbers in that position. As long as the first 4 digits of the SelCall you are sending match those of the radios you are calling, their SelCall alarm will be activated as if their full 5 digit SelCall Idents had been received.

To achieve this, the 10 radios you are calling have sequentially numbered SelCall Idents.

e.g. 14530, 14531, 14532, 14533, 14534, 14535, 14536, 14537, 14538, 14539

Transmitting the SelCall Ident 14531 will only activate the alarm in the radio with the SelCall Ident of 14531. However, transmitting 1453A will activate the alarms in all radios with Idents 14530 through 14539 (a total of 10 radios).

If the radios in your fleet do not have sequential SelCall number and you want to make use of this function, you will need to re-program the SelCall Idents in your radios by changing the numbers in your radio's 'OWN' SelCall memory.

Programming and sending Group Calls

The process for entering a Group Call Ident is the same as entering a normal SelCall Ident.

- 1 Press **MENU**.
- 2 Use the **▲** or **▼** keys to select SelCall and press **MENU** to select.
- 3 Select 'MAKE SelCall' and press **MENU**.
- 4 Use the **▲** or **▼** keys to change the digit at the cursor position. Press **MENU [SEL:NEXT]** to step forward to the NEXT digit position or **BACK** to step back to the previous digit position.
- 5 Repeat until the first 4 digits have been entered. At the last digit use the **▲** or **▼** keys to select 'A'.
- 6 HOLD **MENU [HLD:CALL]** to send.

The  icon will be display as the SelCall is transmitted.

NOTE: Where your radio allows it, programming Group Calls for 100 radios is identical except that you will need to select 'A' for the last two digits (e.g. 123AA). For 1000 radios you will need to select 'A' for last three digits (e.g. 12AAA).

Call acknowledge in Group mode

There is no Call Acknowledge when sending Group Calls. This is to prevent all the radios in your group from trying to respond to your SelCall transmission at the same time.

Storing Group Call idents

Group Call Idents can be stored in memory in the same way as a standard SelCall Ident.

Receiving Group Calls

Receiving a Group Call is identical to receiving a normal SelCall except that the alarm sound is a LOW tone beep instead of the normal High tone beep. The caller's name and number is displayed in the usual way.

MENU OPTIONS

The Menu provides access to all the settings, adjustments and functions listed in the table below. All menu items are controlled using the **MENU**, **▲**, **▼** and **BACK** keys.

- 1 To access the menu, press the **MENU** key.
- 2 To scroll through the list of menu items press the **▲** or **▼** keys.
- 3 To select an item, press the **MENU** key.
- 4 To step back through the menu, or to exit the current screen, HOLD the **BACK** key.

A context menu is included at the bottom of each screen. The options offered will change depending on the selected topic.

SEL:OPTION = briefly press the **MENU** key to select the option.

HLD: OPTION = press and hold the **MENU** key to select the option.

Context menu examples

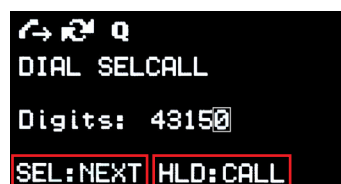

SEL:NEXT =
Press **MENU** for NEXT

HLD:CALL =
Hold **MENU** for NEXT



SEL:NEXT =
Press **MENU** for NEXT

HLD:SAVE =
Hold **MENU** for SAVE

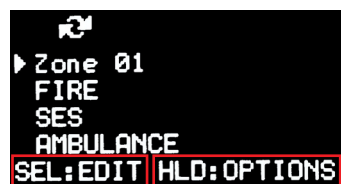

SEL:EDIT =
Press **MENU** for EDIT

HLD:OPTIONS =
Hold **MENU** for OPTIONS

When entering text (e.g. zone names or SelCall numbers), the following characters are available;

Uppercase Letters	A B C D E F G H I J K L M N O P Q R S T U V W X Y Z
Lowercase Letters	a b c d e f g h i j k l m n o p q r s t u v w x y z
Numbers	0 1 2 3 4 5 6 7 8 9
Punctuation	. * + <space>

MENU TABLE

Menu Option	Options	Option Settings
Zones	Zone 1 Zone 2 Zone 3 Zone 4 Zone 5 Zone6 Zone7 Zone8	Go Edit
Prog Buttons	XRS Button Press XRS Button Hold	Dim CB scan memory Quiet memory Quiet mode Scrambler Squelch level Zones
	Top Button Press	Cycle Scan Memory SelCall [CALL]
Functions	Toggle Q memory Toggle Q Mode Toggle Scan Toggle Silent	
Radio Settings	Beep Volume Brightness Busy Lockout CB Subtone Dynamic Volume Control Mic Gain Priority Channel Scrambler Speaker Squelch Level Squelch tail Versions	0 to 10 0 to 10 ON/OFF CTCSS/DCS Tones ON/OFF +0dB to +9dB CB01 to CB80 ON/OFF Radio, Mic, Both 1 to 9 ON/OFF Model, Serial #, Firmware, Bluetooth H/W, Bluetooth F/W. Cancel, Reset radio, Factory Reset
	Reset Settings	
Scan Settings	CB Scan Memory	A Open Scan B Priority Scan C Network Scan
	Netscan Subtone	CTCSS/DCS
SelCall	Make SelCall Last Own Memory - 20	

Receive-only channels (zones)

Your XRS-370C can store up to 400 user-programmable receive-only channels within the frequency range of 403 MHz to 520 MHz. Channels are stored in one of 8 zones with each zone containing up to 50 channels. Zones and channels can each be individually named for easy identification.

Programming is done either through the radio menu or through the GME XRS Connect App. The XRS Connect App also offers a range of pre-programmed frequencies in various categories sorted by locations making the selection of suitable channels and frequencies much easier.

When a Zone is selected, its frequencies will be added to the standard 80 CB channels. Zone channels appear immediately above CH80. After the last zone channel is selected channels will wrap around to CH01 again.







Select a zone

Press MENU . Select ZONES and press MENU .	
Select the desired Zone from the Zone list. Press MENU [SEL:GO] .	
The radio returns to the main screen with the selected zone displayed below the channel number. All channels in the selected zone will now be available along with the usual 80 CB channels. Zone channels can be found immediately above CB Channel 80.	



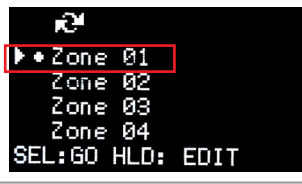

Edit a zone name

Press MENU . Select ZONES and press MENU .	
Select the desired Zone from the Zone list and HOLD MENU [HLD:EDIT] to edit the zone.	
The zone edit screen appears. Press MENU [SEL:EDIT] to edit the zone name.	
Use the ▲ or ▼ keys to change the character at the cursor position. Press the MENU key to step forward to the NEXT character position or the BACK key to step back to the previous character position.	
Continue until the desired name has been entered. Zone names can be up to 16 characters long. To save the name HOLD the MENU key [HLD:SAVE] .	
The radio will return to the Zone list with the new zone name displayed	

Add channels to a new zone

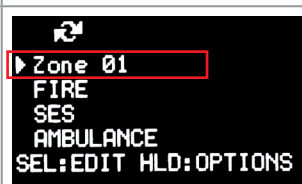
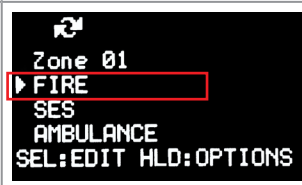
<p>Press MENU.</p> <p>Select ZONES and press MENU.</p>	
<p>Select the desired Zone from the Zone list and HOLD MENU [HLD:EDIT] to edit the zone.</p>	
<p>Hold MENU [HLD:OPTIONS] to select Options.</p>	
<p>Use the ▲ or ▼ keys to select Add Channel from the menu list.</p> <p>Press MENU [SEL:EDIT] to edit the new channel.</p>	
<p>Use the ▲ or ▼ keys to change the character at the cursor position. Press MENU to step forward to the NEXT character position or the BACK key to step back to the previous character position. When the desired name has been entered, press the MENU key repeatedly to step to the RX frequency. Channel names may contain up to 16 characters.</p> <p>Press the MENU key repeatedly to step to the RX frequency.</p>	
<p>Use the ▲ or ▼ keys to change the frequency digit. Press MENU to step to the NEXT digit position or BACK to return to the previous digit position.</p> <p>When editing the kHz digits the entire block of kHz digits will change in 12.5 kHz steps.</p> <p>To save the new channel, Hold MENU [HLD:SAVE].</p>	
<p>The display return to the Zone screen.</p>	

Edit existing channels in a zone

<p>Press MENU.</p> <p>Select ZONES and press MENU.</p>	
<p>Select the desired Zone from the Zone list and HOLD MENU [HLD:EDIT] to edit the zone.</p>	
<p>Use the ▲ or ▼ keys to select a channel</p> <p>HOLD MENU [HLD:OPTIONS] for the Options menu</p>	
<p>Use the ▲ or ▼ keys to select from the options list them press MENU.</p> <ul style="list-style-type: none"> Select 'Go Channel' to jump to the select channel Select 'Del Channel' to delete the selected channel Select 'Add Channel' to add a new channel Select 'Edit' to edit the selected channel <p>then select MENU [SEL:EDIT].</p>	
<p>To ADD a new channel or EDIT an existing channel;</p> <ul style="list-style-type: none"> Use the ▲ or ▼ keys to change the character or digit at the cursor position. Press MENU to step forward to the NEXT character or digit position or the BACK key to step back to the previous character or digit position. <p>Continue until the name or frequency has been edited.</p> <p>HOLD MENU [HLD:SAVE] to save.</p>	 

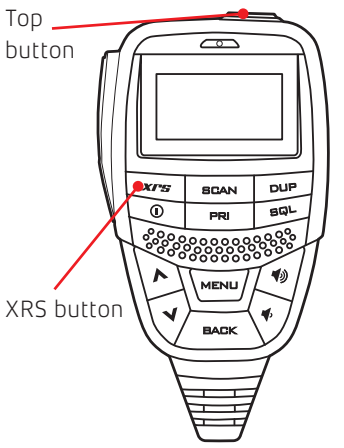
Button	Option	Description	
	XRS button press	Display Dim	
	XRS button hold	CB Scan Memory	Cycles through the three Scan memories
		Quiet Memory	Stores channels in the SelCall Quiet memory
	Top button press	Quiet Mode	Toggles SelCall Quiet mode on or off
		Scrambler	Enables or disables the scrambler option
		Squelch Level	Adjusts the preset squelch level in steps from 1 to 9
	Top button press	Zones	Displays the Zone list menu for quick zone selection
Cycle Scan Memory		Cycles through the channels stored in the current scan memory	
	SelCall Call function	Provides the standard Call button functions i.e. Press to enter SelCall entry menu Hold to send last SelCall	

To select programmable button options

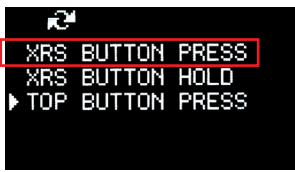
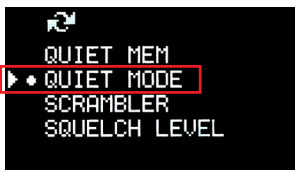
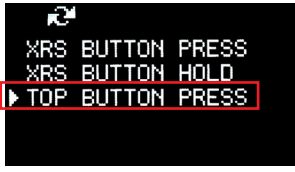
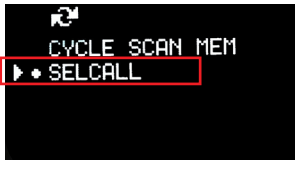
<p>Press MENU.</p> <p>Use the ▲ or ▼ keys to select 'PROG BUTTONS' then press MENU to select.</p>	
<p>XRS Button Programming</p> <p>Use the ▲ or ▼ keys to select 'XRS BUTTON PRESS' or 'XRS BUTTON HOLD' then press MENU.</p>	
<p>The XRS Button option list is displayed. The currently selected option is marked with a dot. Use the ▲ or ▼ keys to select to desired option then press MENU to select.</p>	
<p>Press BACK to exit back to the previous menu or HOLD BACK to return to the main screen.</p>	
<p>Top Button Programming</p> <p>Use the ▲ or ▼ keys to select 'TOP BUTTON PRESS' then press MENU.</p>	
<p>The TOP Button option list is displayed. The currently selected option is marked with a dot. Use the ▲ or ▼ keys to select to desired option then press MENU to select.</p>	
<p>Press BACK to exit back to the previous menu or HOLD BACK to return to the main screen.</p>	

Functions

The Function option allows you to set the state of several functions related to Scan, SelCall and CTCSS/DCS.

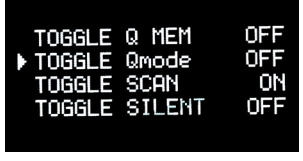
<p>Press MENU.</p> <p>Use the ▲ or ▼ keys to select 'FUNCTIONS' then press MENU.</p>	
<p>Use the ▲ or ▼ keys to select from one of the options below;</p> <p>TOGGLE 'Q' MEM: Store channels in the SelCall Quiet memory.</p> <p>TOGGLE Qmode: Toggle Quiet mode for SelCall.</p> <p>TOGGLE SCAN: Enable/Disable the Scan function.</p> <p>TOGGLE SILENT: Toggle Silent mode for CTCSS/DCS channels.</p> <p>Press MENU to toggle the selected function ON or OFF.</p>	
<p>Press BACK to exit back to the previous menu or HOLD BACK to return to the main screen.</p>	

Radio settings

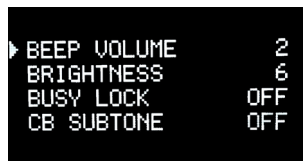
<p>Press MENU.</p> <p>Use the ▲ or ▼ keys to select 'RADIO SETTINGS' then press MENU.</p>	
<p>Use the ▲ or ▼ keys to select from one of the setting options (see the options table below. To alter a value (e.g. Beep Volume) press MENU then use the ▲ or ▼ keys to adjust the value. Press MENU to accept. To toggle an ON/OFF setting, press MENU.</p>	
<p>Press BACK to return to the previous menu or HOLD BACK to return to the main screen.</p>	



Radio setting options table

Menu Item	Description	Setting
BEEP VOLUME	Adjusts the volume of the key press beeps.	0 to 10 [4]
BRIGHTNESS	Adjusts the OLED and keypad brightness.	0 to 10 [5]
BUSY LOCK	Disables the transmitter when the radio is busy to prevent you from transmitting over the top of other users	ON/OFF [OFF]
CB SUBTONE	Switches the CTCSS or DCS tone Off or ON and sets the tone frequency.	OFF [OFF] CTC01 – CTC50 DT001 – DT104
DYNAMIC VOL	Balances the volume level of incoming signals so that soft and loud signals have a similar volume.	ON/OFF [ON]
MIC GAIN	Adjusts the microphone's sensitivity. Increase the gain for quiet voices. Decrease the gain for loud voices or for use in noisy environments.	+0dB to +9dB [+0dB]
PRIORITY CH	Sets the channel that is selected when the PRI key is pressed.	CB01 – CB80 [CB01]
SCRAMBLER	Enables/Disables the Scrambler option	ON/OFF [OFF]
SPEAKER	Selects which speakers are in use. Sounds can be heard through radio speaker only, microphone speaker only, or both speakers at once	Radio, Mic, Both [Both]
SQUELCH LEVEL	Adjusts the present squelch level.	1 to 9 [1]
SQUELCH TAIL	Enables/Disables the squelch tail. When set to OFF the squelch tail is silent.	ON/OFF [ON]
VERSIONS	Displays model number, serial number, firmware, Bluetooth wireless technology enabled hardware and Bluetooth wireless technology enabled software.	Model, Serial #, Firmware, Bluetooth H/W, Bluetooth S/W
RESET SETTINGS	Cancel: Exits without changes. Reset Radio: Restores the radio to its default settings (i.e Squelch level, beep level, Subtone, etc. but retains user data such as SelCall memories and Zones. Factory Reset: Restores the radio to its 'out-of-the-box' state. Deletes all user data and restores default settings.	

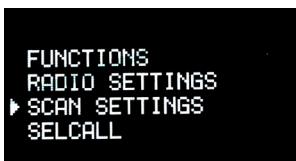
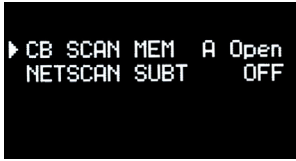
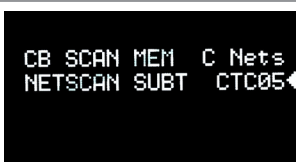
Scan settings

<p>Press MENU.</p> <p>Use the ▲ or ▼ keys to select 'SCAN SETTINGS' then press MENU.</p>	
<p>Use the ▲ or ▼ keys to select 'CB SCAN MEM' then press MENU.</p> <p>Use the ▲ or ▼ keys to select from memory 'A', 'B' or 'C' then press MENU.</p> <p>The default scan memory allocations are; A – Open Scan B – Priority Scan C – Netscan</p> <p>The default allocations can be changed using the Smart phone App.</p>	
<p>Net-Scan</p> <p>To use Net-Scan you must also select a CTCSS or DCS sub-tone</p> <p>Use the ▲ or ▼ keys to select 'NETSCAN SUBT' then press MENU.</p> <p>Use the ▲ or ▼ keys to scroll through the list of sub-tones then press MENU to select.</p> <p>NOTE: If you select Netscan as your CB Scan Memory without selecting a sub-tone, you will not be able to scan. Pressing the SCAN key will give a low 'error' beep.</p>	

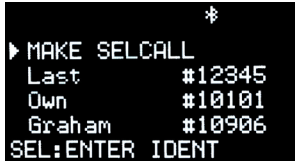
SelCall

<p>Press MENU.</p> <p>Use the ▲ or ▼ keys to select 'SelCall' then press MENU.</p>	
<p>Use the ▲ or ▼ keys to select the available options.</p> <ul style="list-style-type: none"> Select 'MAKE SelCall' to enter and send a SelCall number. Select 'Last' to resend or save the last SelCall number you sent. Select 'Own' to edit your radio's own SelCall number. Continue scrolling downwards to access a further 20 user programmable SelCall memories. 	
<p>Make SelCall</p> <p>To enter and send a SelCall number, select 'MAKE SelCall' and press MENU [SEL:ENTER].</p> <p>Use the ▲ or ▼ keys to change the digit at the cursor position.</p> <p>Press MENU [SEL:NEXT] to step forward to the NEXT digit position or BACK to step back to the previous digit position.</p> <p>Continue until all 5 SelCall digits have been entered. HOLD MENU [HLD:CALL] to send.</p>	 

Resend the LAST SelCall number

Use the **▲** or **▼** keys to select 'Last', then HOLD **MENU** [HLD:CALL] to resend the last SelCall number.

```
MAKE SELCALL
▶ Last      #12345
  Own       #10101
  Graham    #10906
SEL:SAVE HLD:CALL
```

Save the LAST SelCall number in memory

Use the **▲** or **▼** keys to select 'Last' and press **MENU** [SEL:SAVE] to save the last SelCall number into one of the memories. 'Select Slot to Save' is displayed.

Use the **▲** or **▼** keys to scroll down to an empty SelCall memory then press **MENU** [SEL:EDIT].

The 'Edit Contact' screen is displayed and the SelCall number is automatically inserted into the contact.

To edit the contact name;

- Use the **▲** or **▼** keys to change the character or the cursor position.
- Press **MENU** [SEL:NEXT] to step forward to the NEXT character position or **BACK** to step back to the previous character position.

Continue until the required name has been entered then HOLD **MENU** [HLD:SAVE] to save the contact.

```
MAKE SELCALL
▶ Last      #12345
  Own       #10101
  Graham    #10906
SELECT SLOT TO SAVE
```

```
Graham    #10906
▶          #-----
           #-----
           #-----
SEL:EDIT
```

```
EDIT CONTACT
Name:      █
Digits:    12345
SEL:NEXT HLD:SAVE
```

Edit your radio's OWN SelCall number

Use the **▲** or **▼** keys to select 'Own' then press **MENU** to edit your radio's own SelCall number.

The 'Edit Contact' screen is displayed and 'Own' is displayed as the contact name with the cursor on the SelCall number.

Use the **▲** or **▼** keys to change the number or the cursor position.

Press **MENU** [SEL:NEXT] to step forward to the NEXT digit position or **BACK** to step back to the previous digit position.

Continue until the required name has been entered, then HOLD **MENU** [HLD:SAVE] to save the new number.

```
MAKE SELCALL
Last      #12345
▶ Own     #10101
  Graham  #10906
SEL:ENTER IDENT
```

```
EDIT CONTACT
Name:      Own
Digits:    00101
SEL:NEXT HLD:SAVE
```

Add a NEW contact to the SelCall Memory

Use the **▲** or **▼** keys to scroll to an empty SelCall memory then press **MENU** [SEL:EDIT] to edit

```
Graham    #10906
▶          #-----
           #-----
           #-----
SEL:EDIT
```

Use the **▲** or **▼** keys to change the letter or number at the cursor position.

Press **MENU** [SEL:NEXT] to step forward to the NEXT character or digit position or the **BACK** key to step back to the previous character or digit position.

Continue until the required name and SelCall number has been entered then HOLD **MENU** [HLD:SAVE] to save the new number.

The radio returns to the previous screen and displays the new contact entry.

```
EDIT CONTACT
Name:      █
Digits:    00000
SEL:NEXT HLD:SAVE
```

```
EDIT CONTACT
Name:      Roger
Digits:    42510
SEL:NEXT HLD:SAVE
```

```
Last      #12345
Own       #10101
Graham    #10906
▶ Roger    #42510
SEL:EDIT HLD:CALL
```

INSTALLATION

General

Your radio is supplied with a slim, slide on mounting cradle. As the radio contains a built-in speaker, the cradle can be screwed or bolted to any convenient location in your vehicle's cabin (under or above the dash or on the centre console) using the mounting slots provided in the cradle.

When planning your installation, avoid locations that are close to heaters or air conditioners.

Installation

For maximum sound projection from the internal speaker, we recommend the cradle be mounted above the radio to minimise any obstruction of the speaker. Alternatively, if it is necessary to mount the unit in a less audible location, an extension speaker can be used. The extension speaker plugs into the extension speaker socket on the radio's rear panel.

Installing the cradle

Screw the mounting cradle to a firm surface then slide the radio's main unit into the cradle from the front until it clicks into place. Finally, connect the power lead, antenna cable and extension speaker (if required) to the sockets on the radio's rear panel.

Mounting the cradle

Option 1

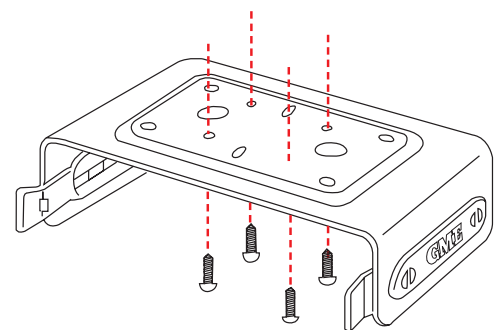

Option 2

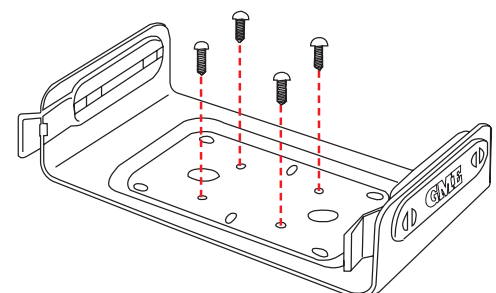

Fitting the radio

Slide radio fully into cradle until it clicks into place.

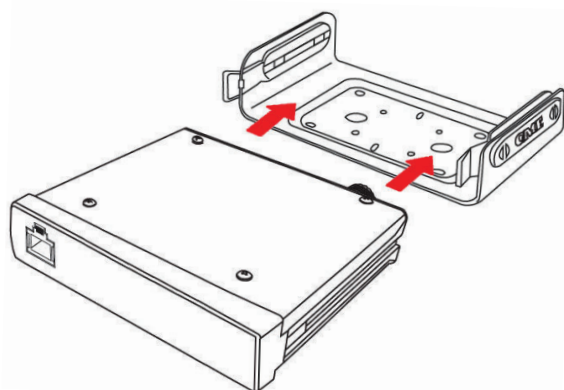

Removing the radio

If the main unit is installed in a remote location, you may need to install an extension speaker inside the cabin. The extension speaker plugs into the extension speaker socket on the rear panel of the main unit.

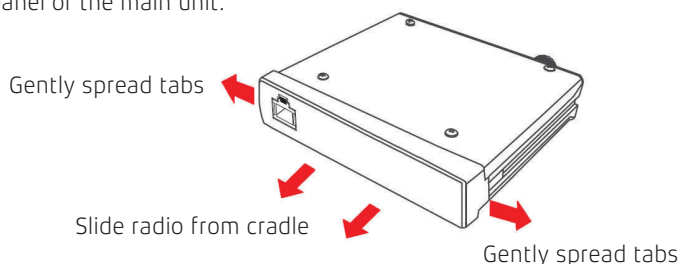

Fitting the controller microphone

Plug the 8 pin plug into the socket on the front of the main unit or alternatively you can use the adapter and extension cable supplied with the radio. If the main unit is not easily accessible this adapter will allow you to bring the microphone socket to a more convenient position. Attach the microphone clip to a convenient location near your driving position using screws. Slide the bollard on the back of the microphone into the clip to secure it.

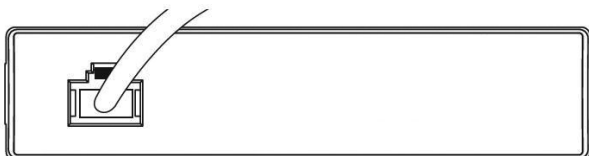

DC power connection

The radio is designed for 13.8 volt DC, negative earth installations only (i.e. Where the negative terminal of the battery is connected to the chassis or frame of the vehicle).

There are two recommended methods of installation.

Radio remains ON when the ignition switch is OFF

Connect the radio's negative (black) lead to the vehicle's chassis, or if preferred, directly to the battery's negative terminal. The radio's positive (red) lead should be connected via the 2 amp fuse to the battery's positive terminal.

Alternatively, the positive lead could be connected into the fuse box at a point that has +13.8 volts continuously available (on the battery side of the ignition switch) via the 2 amp fuse.

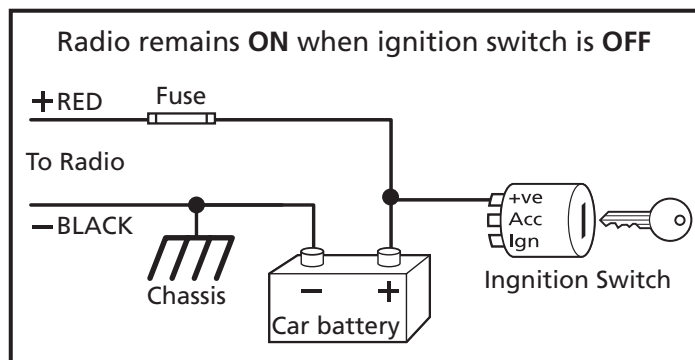

Radio turns ON and OFF with the ignition switch

Connect the radio's negative (black) lead to the vehicle's chassis, or if preferred, directly to the battery's negative terminal. The radio's positive (red) lead should connect to an accessory point in the vehicle's fuse box via the 2 amp fuse. This point should supply +13.8 volts only when the ignition switch is turned ON or in the ACCESSORY position via the 2 amp fuse.

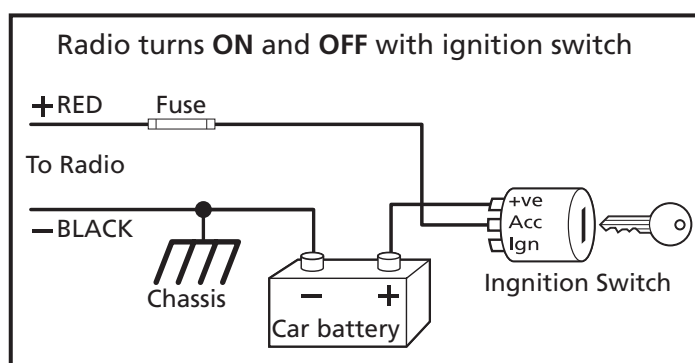

High voltage detection

The radio has a built-in, high voltage detection system to warn you if an over voltage situation occurs. If the power supply voltage exceeds 18 volts DC, the display will flash 'High DC' for 1 second and will sound a warning beep. If you are transmitting, 'High DC' will be displayed and the output power will be reduced to 1 watt.

If the 'High DC' warning appears you should switch your radio OFF and disconnect it from the power source, before locating the cause of the trouble.

NOTE: The High DC warning will remain on the display even if the normal voltage level is restored. You will need to switch the radio OFF then ON again to reset it and clear the 'High DC' warning.

IMPORTANT: The power source should never exceed 30 volts.

Antenna connection

It is essential to select a good quality, high efficiency, 477 MHz antenna. A poor quality antenna or one not designed for the specific frequency band you are using will give very poor performance.

GME have a wide range of suitable 477 MHz UHF CB antennas to suit most installations and applications. We recommend contacting your local GME retailer for advice.

Connect to the antenna cable to the rear antenna socket using a PL259 coaxial connector.

Noise suppression

The inherent design of FM transceivers results in a high level of resistance to ignition and electrical interference. However in some installations it may be necessary to take additional steps to help reduce or eliminate noise interference.

During installation, try to route the DC battery leads, the antenna lead or any accessory wires away from the engine compartment,

ignition or alternator wiring. If the noise continues, it may be necessary to fit a suppression kit in which case we recommend you consult an auto electrician for advice specific to your installation.

Higher frequency electrical interference cause by electric motors can be suppressed directly at the motor terminals.

Wiring

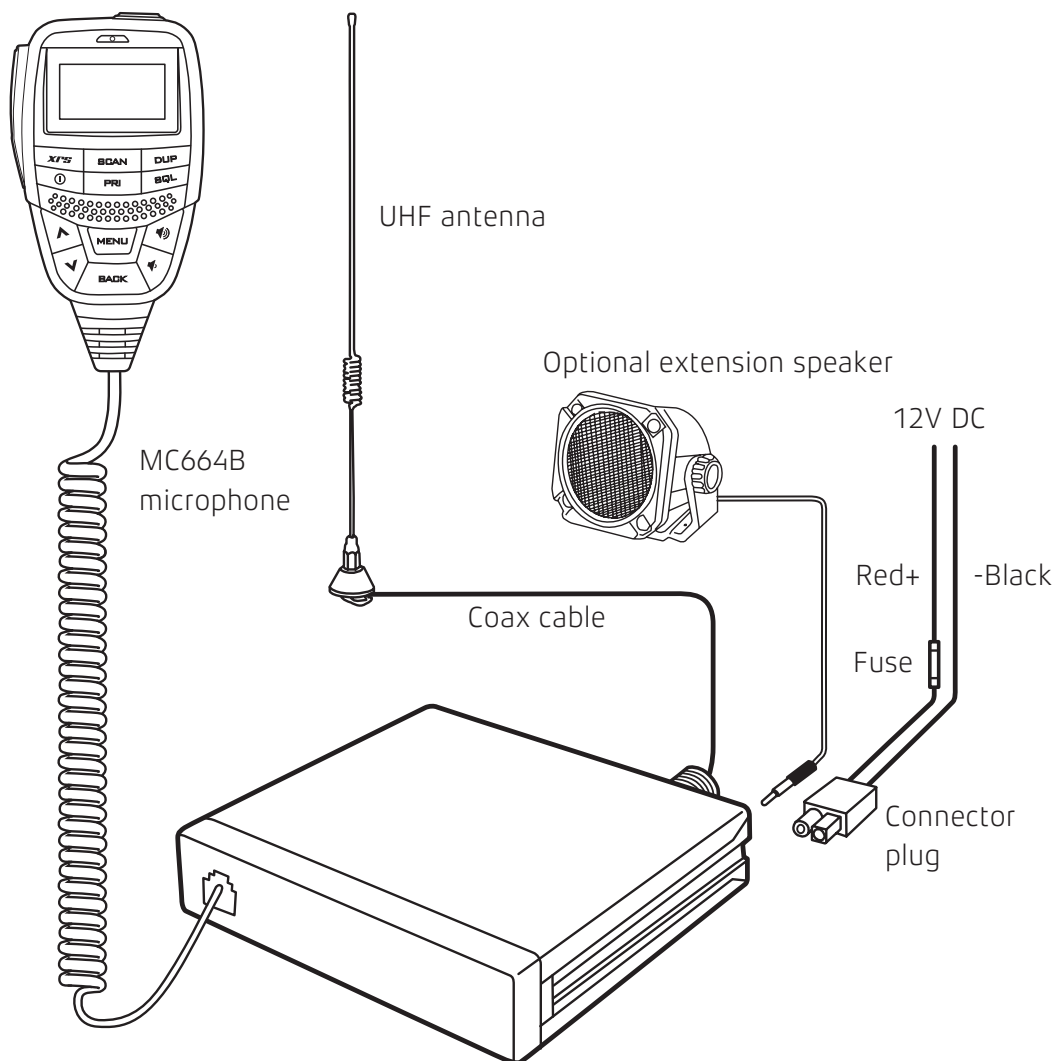

FREQUENCY AND SUBTONE TABLES

CTCSS TONE FREQUENCIES							
No.	Frequency	No.	Frequency	No.	Frequency	No.	Frequency
1	67.0	14	107.2	27	167.9	40	159.8
2	71.9	15	110.9	28	173.8	41	165.5
3	74.4	16	114.8	29	179.9	42	171.3
4	77.0	17	118.8	30	186.2	43	177.3
5	79.7	18	123.0	31	192.8	44	183.5
6	82.5	19	127.3	32	203.5	45	189.9
7	85.4	20	131.8	33	210.7	46	196.6
8	88.5	21	136.5	34	218.1	47	199.5
9	91.5	22	141.3	35	225.7	48	206.5
10	94.8	23	146.2	36	233.6	49	229.1
11	97.4	24	151.4	37	241.8	50	254.1
12	100.0	25	156.7	38	250.3	-	-
13	103.5	26	162.2	39	269.4	-	-

DCS CODES											
DCS	CODE	DCS	CODE	DCS	CODE	DCS	CODE	DCS	CODE	DCS	CODE
1	023	19	116	37	225	55	325	73	452	91	627
2	025	20	122	38	226	56	331	74	454	92	631
3	026	21	125	39	243	57	332	75	455	93	632
4	031	22	131	40	244	58	343	76	462	94	654
5	032	23	132	41	245	59	346	77	464	95	662
6	036	24	134	42	246	60	351	78	465	96	664
7	043	25	143	43	251	61	356	79	466	97	703
8	047	26	145	44	252	62	364	80	503	98	712
9	051	27	152	45	255	63	365	81	506	99	723
10	053	28	155	46	261	64	371	82	516	100	731
11	054	29	156	47	263	65	411	83	523	101	732
12	065	30	162	48	265	66	412	84	526	102	734
13	071	31	165	49	266	67	413	85	532	103	743
14	072	32	172	50	271	68	423	86	546	104	754
15	073	33	174	51	274	69	431	87	565	-	-
16	074	34	205	52	306	70	432	88	606		
17	114	35	212	53	311	71	445	89	612	-	-
18	115	36	223	54	315	72	446	90	624	-	-

UHF CB OPERATING FREQUENCIES							
CH	Frequency (MHz)	CH	Frequency (MHz)	CH	Frequency (MHz)	CH	Frequency (MHz)
1	476.425	21	476.925	41	476.4375	61	476.9375
2	476.450	22	476.950	42	476.4625	62	476.9625
3	476.475	23	476.975	43	476.4875	63	476.9875
4	476.500	24	477.000	44	476.5125	64	477.0125
5	476.525	25	477.025	45	476.5375	65	477.0375
6	476.550	26	477.050	46	476.5625	66	477.0625
7	476.575	27	477.075	47	476.5875	67	477.0875
8	476.600	28	477.100	48	476.6125	68	477.1125
9	476.625	29	477.125	49	476.6375	69	477.1375
10	476.650	30	477.150	50	476.6625	70	477.1625
11	476.675	31	477.175	51	476.6875	71	477.1875
12	476.700	32	477.200	52	476.7125	72	477.2125
13	476.725	33	477.225	53	476.7375	73	477.2375
14	476.750	34	477.250	54	476.7625	74	477.2625
15	476.775	35	477.275	55	476.7875	75	477.2875
16	476.800	36	477.300	56	476.8125	76	477.3125
17	476.825	37	477.325	57	476.8375	77	477.3375
18	476.850	38	477.350	58	476.8625	78	477.3625
19	476.875	39	477.375	59	476.8875	79	477.3875
20	476.900	40	477.400	60	476.9125	80	477.4125

61	Emergency use only
62	Telemetry / SelCall use only. Voice transmission is inhibited as required by AS/ NZS 4365.2011
63	Telemetry / SelCall use only. Voice transmission is inhibited as required by AS/ NZS 4365.2011
64	Telemetry / SelCall use only. Voice transmission is inhibited as required by AS/ NZS 4365.2011
65	Telemetry / SelCall use only. Voice transmission is inhibited as required by AS/ NZS 4365.2011
66	Telemetry / SelCall use only. Voice transmission is inhibited as required by AS/ NZS 4365.2011
67	Telemetry / SelCall use only. Voice transmission is inhibited as required by AS/ NZS 4365.2011
68	Telemetry / SelCall use only. Voice transmission is inhibited as required by AS/ NZS 4365.2011
69	Telemetry / SelCall use only. Voice transmission is inhibited as required by AS/ NZS 4365.2011
70	Telemetry / SelCall use only. Voice transmission is inhibited as required by AS/ NZS 4365.2011
71	Telemetry / SelCall use only. Voice transmission is inhibited as required by AS/ NZS 4365.2011
72	Telemetry / SelCall use only. Voice transmission is inhibited as required by AS/ NZS 4365.2011
73	Telemetry / SelCall use only. Voice transmission is inhibited as required by AS/ NZS 4365.2011
74	Telemetry / SelCall use only. Voice transmission is inhibited as required by AS/ NZS 4365.2011
75	Telemetry / SelCall use only. Voice transmission is inhibited as required by AS/ NZS 4365.2011
76	Telemetry / SelCall use only. Voice transmission is inhibited as required by AS/ NZS 4365.2011
77	Telemetry / SelCall use only. Voice transmission is inhibited as required by AS/ NZS 4365.2011
78	Telemetry / SelCall use only. Voice transmission is inhibited as required by AS/ NZS 4365.2011
79	Telemetry / SelCall use only. Voice transmission is inhibited as required by AS/ NZS 4365.2011
80	Telemetry / SelCall use only. Voice transmission is inhibited as required by AS/ NZS 4365.2011
11	Officially designated call channel
40	Road channel
18	Caravan and motor-home
10	4WD / Off-road

SPECIFICATIONS

Electrical

GENERAL

Compliant Specification:	Meets AS/NZS 4365 for radio communications equipment in the UHF citizen and personal radio service.
Frequency Range TX:	476.425-477.4125 MHz
Number of Channels:	80
Channel Spacing:	12.5 kHz
Operation Mode:	Simplex or half Duplex with repeater talk-around.
Scanning Speed:	20 ms per channel (50 channels per second).
Antenna Impedance:	50 Ohms nominal
Nominal Battery Voltage:	12 volts DC
Operating Voltage Range:	10 - 16 volts DC
Battery Polarity:	Negative Earth
Standard Test Voltage:	13.8 volts DC
Over Voltage Protection:	30 volts DC maximum. At 18 volts DC the channel display flashes 'Hi DC' for 5 seconds on receive. The RF power is reduced and TX flashes on transmit.
Reverse Voltage Protection:	Diode Crowbar
Over-current Protection:	In-line 2 amp fuse
Operating Temperature:	-10° C to +60°C

TRANSMITTER

R F Output:	5 watts
Spurious Emission:	< - 70 dBc
Frequency Error:	< ± 1.5 kHz
Modulation:	FM
Maximum Deviation:	< ± 2.5 kHz at + 20 Db AF limiting.
Transmit Frequency Response:	+6 dB per octave 300 Hz to 3 kHz + 1 . 3 dB.
Demodulated Audio Signal to Noise:	>45 dB unweighted
Current Consumption:	1.7 amps with 50 Ohms termination.

RECEIVER

Intermediate Frequencies:	38.85 MHz, 450 kHz
Sensitivity:	-122 dBm for 12 dB SINAD unweighted
Selectivity:	-6 dB at ± 3.5 kHz, -60 dB at ± 12.5 kHz
Intermodulation Immunity:	-72 dB
Blocking Immunity:	-98 dB
Spurious Response Immunity:	70 dB
Audio Output Power:	3 watts average into 4 Ohms
Audio Signal to Noise:	>45 dB unweighted
Receive Frequency Response:	-6 dB/Octave de-emphasis 300 Hz to 3 kHz +1 -3 dB.
Current Consumption:	<175 mA muted, 750 mA full volume.
Conducted Spurious Emission:	<70 dBm

Mechanical specifications and connections

Dimensions:	29 (H) x 128 (L) x 117 (D) mm
Weight:	450 grams
12 volt Power Supply:	Two core cable with bulkhead connector in rear panel.
Antenna:	SO 239 panel socket
External Speaker:	3.5 mm mono jack
Front Microphone Port:	8 way telephone style with rubber strain relief.

Specifications are subject to change without notice or obligation

LOCATION SERVICES

XRS Location Services App

The XRS Location Services app is used with the XRS Connect radio and is available for iOS and Android devices. It connects to the XRS Connect radio using Bluetooth. To use XRS Location Services, download the app to your mobile device and update the radio firmware.

XRS Location Services allows users to share their location using the mobile device's GPS location. The location is broadcast by the radio at the end of a normal voice transmission. The location cannot be shared by the app without being connected to an XRS Connect radio.

GME values your privacy. The location data is only stored within the XRS Location Services app and is transmitted from your XRS Connect radio. GME does not collect any of the location data.

XRS Location Services enables the CB radio user to transmit their geographic location as a supplementary service to voice communication on CB channels. This feature complies with the Radiocommunications (Citizen Band Radio Stations) Class Licence 2015.

Bluetooth

Secure Pairing

Use this to turn secure PIN pairing on or off for your Bluetooth connection. If secure pairing is turned on when pairing your mobile device with the XRS radio for the first time, you will be asked to confirm a security PIN on both the mobile device with the XRS location services app and your radio.

With Secure pair turned on you must put the radio into Pair mode using the Pair menu option before connecting your XRS Location Services app.

Pair

When Secure Pairing is turned on you must select Pair in the Bluetooth menu to put the radio into pair mode before you can connect for the first time. Pair mode will timeout after 90 seconds.

Radio Settings Options Table

Menu Option	Options	Option Settings
SELCALL ACK	Enables/disables automatic transmission of an acknowledge beep when your SelCall Ident is received.	On/Off

Location Services Options Table

Menu Option	Options	Option Settings
LOCATION TX	Enables/disables whether the radio transmits location to other radios (same as share location in XRS Locations Services app).	On/Off
LOC TIMEOUT	If the location timestamp the radio has is more then x minutes old it will not be transmitted. 0= no timeout. Maximum setting is 180 minutes.	Minutes
MIC DISPLAY	Loc= Microphone will display @username direction and distance for incoming transmission. Txt=Mic will display @username and #status for incoming transmission. Off=No display.	Loc/Txt/Off
SELCALL UID	Turn on to include the radio's SelCall ID in the location data sent.	On/Off

STANDARD COMMUNICATIONS CONTRACT WARRANTY AGAINST DEFECTS

This warranty against defects is given by Standard Communications Pty Ltd ACN 000 346 814 (We, us, our or GME). Our contact details are set out in clause 2.7.

1. Consumer guarantees

1.1 Our goods come with guarantees that cannot be excluded under the Australian Consumer Law. You are entitled to a replacement or refund for a major failure and for compensation for any other reasonably foreseeable loss or damage. You are also entitled to have the goods repaired or replaced if the goods fail to be of acceptable quality and the failure does not amount to a major failure.

1.2 To the extent we are able, we exclude all other conditions, warranties and obligations which would otherwise be implied.

2. Warranty against defects

2.1 This warranty is in addition to and does not limit, exclude or restrict your rights under the Competition and Consumer Act 2010 (Australia) or any other mandatory protection laws that may apply.

2.2 We warrant our goods to be free from defects in materials and workmanship for the warranty period (see warranty table) from the date of original sale (or another period we agree to in writing). Subject to our obligations under clause 1.2, we will at our option, either repair or replace goods which we are satisfied are defective. We warrant any replacement parts for the remainder of the period of warranty for the goods into which they are incorporated.

2.3 To the extent permitted by law, our sole liability for breach of a condition, warranty or other obligation implied by law is limited

(a) in the case of goods we supply, to any one of the following as we decide –

(i) the replacement of the goods or the supply of equivalent goods;

(ii) the repair of the goods;

(iii) the cost of repairing the goods or of acquiring equivalent goods;

(b) in the case of services we supply, to any one of the following as we decide –

(i) the supplying of the services again;

(ii) the cost of having the services supplied again.

2.4 For repairs outside the warranty period, we warrant our repairs to be free from defects in materials and workmanship for three months from the date of the original repair. We agree to re-repair or replace (at our option) any materials or workmanship which we are satisfied are defective.

2.5 We warrant that we will perform services with reasonable care and skill and agree to investigate any complaint regarding our services made in good faith. If we are satisfied that the complaint is justified, and as our sole liability to you under this warranty (to the extent permitted at law), we agree to supply those services again at no extra charge to you.

2.6 To make a warranty claim you must before the end of the applicable warranty period (see warranty table), at your own cost, return the goods you allege are defective, provide written details of the defect, and give us an original or copy of the sales invoice or some other evidence showing details of the transaction.

2.7 Send your claim to: Standard Communications Pty Ltd.
PO Box 96 Winston Hills, NSW 2153, Australia.
Tel: (02) 8867 6000 Fax: (02) 8867 6199
Email: servadmin@gme.net.au

2.8 If we determine that your goods are defective, we will pay for the cost of returning the repaired or replaced goods to you, and reimburse you for your reasonable expenses of sending your warranty claim to us.

3. What this warranty does not cover

3.1 This warranty will not apply in relation to:

(a) goods modified or altered in any way;

(b) defects and damage caused by use with non Standard Communications products;

(c) repairs performed other than by our authorised representative;

(d) defects or damage resulting from misuse, accident, impact or neglect;

(e) goods improperly installed or used in a manner contrary to the relevant instruction manual; or



(f) goods where the serial number has been removed or made illegal.

4. Warranty period

4.1 We provide the following warranty on GME and Kingray products. No repair or replacement during the warranty period will renew or extend the warranty period past the period from original date of purchase.

PRODUCT TYPE	WARRANTY PERIOD
477 MHz UHF CB mobile radios	5 years

For more information call or visit us:

 1300 463 463  gme.net.au

A division of Standard Communications Pty Ltd.

Head Office: PO Box 96, Winston Hills, NSW 2153, Australia

New Zealand: PO Box 58446 Botany, Auckland, 2163, NZ T: (09) 274 0955

All international enquiries email: export@gme.net.au

Find us on 

Part Number: 311022 Drawing Number: 49290-2



Requires Bluetooth® 2.1 (Android 5.0 or later)
or Bluetooth® 4.0 (iOS 9.0 or later).

The Bluetooth® word mark and logos are registered trademarks owned by Bluetooth SIG, Inc. and any use of such marks by GME is under license. Other trademarks and trade names are those of their respective owners.

Apple and the Apple logo are trademarks of Apple Inc., registered in the U.S. and other countries. App Store is a service mark of Apple Inc.

Google Play and the Google Play logo are trademarks of Google Inc.