

Do not drill or damage side airbag. It is the responsibility of the installer to ensure airbag is not damaged during or after installation.

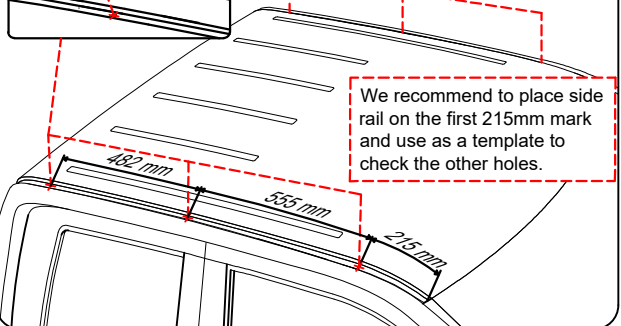

- 32 M8 X 25 Allen Cap X6
- 26 M8 WASHER X6
- 36 M8 Threaded Rivet X6

1- Use SEALANT around all roof holes, before and after place M8 Threaded Rivet, to protect and seal.
 2- Clean the sealant excess after placement of roof brackets.

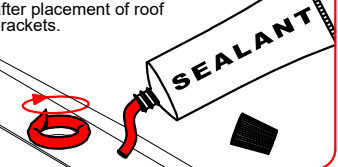

TMX RR 012 103231 LH - RH

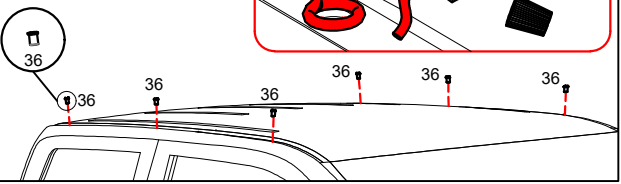

Fit side under rails with Allen cap M8 on drilled holes and tighten.

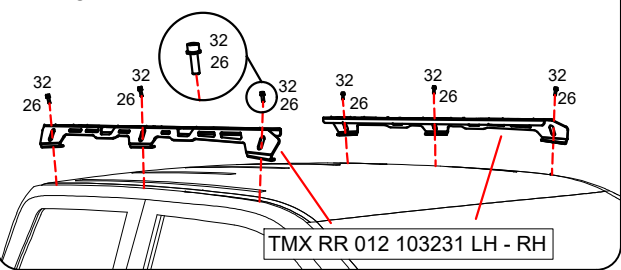

RAM 1500 QUAD CAB 103272



After under rails have been fitted, place roof rack up to side under rails brackets, and fasten as per following diagram

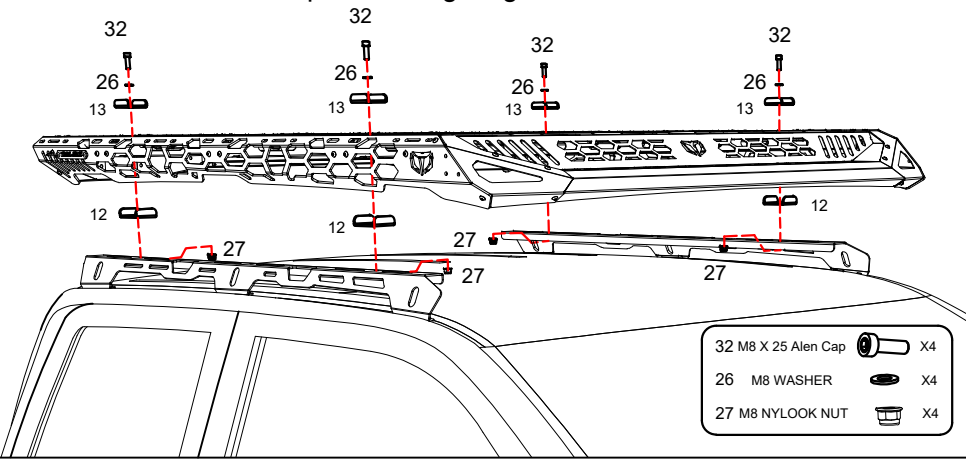

- 32 M8 X 25 Allen Cap X4
- 26 M8 WASHER X4
- 27 M8 NYLOOK NUT X4

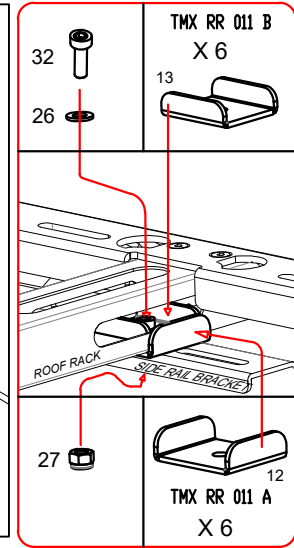

Tighten all M8 Allen cap bolts and M8 nuts using 6mm Allen key and 13mm Wrench.

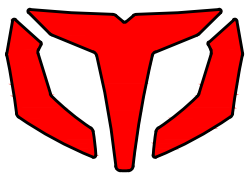

DONE!

TMX RR 103231 BRACKET BOLT KIT			
Item N°	Part	Description	Qty
27	M8 1.25 flange nylock nut		4
26	M8 washer		10
32	M8 1.25 x 25 Allen Cap		10
36	M8 Nut Insert, 3 - 5.5mm grip		6

